

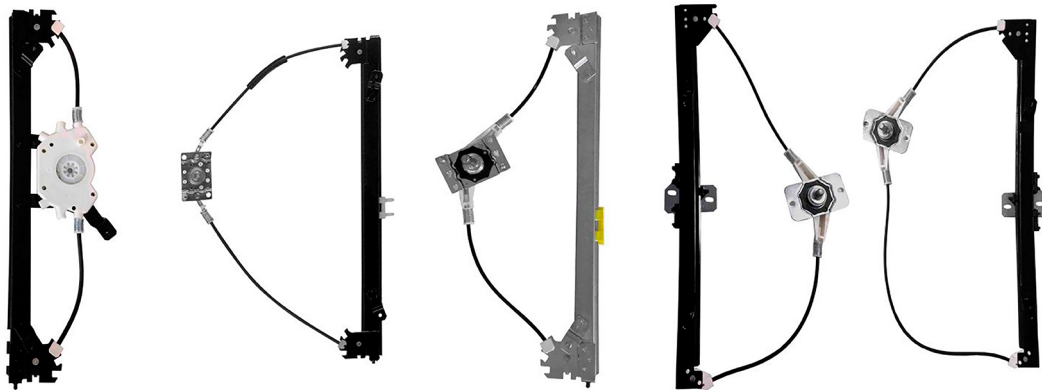

Zinni & Güell

Indústria de Auto Peças Ltda.



CATALOGO COMPLETO
SIN MÁQUINAS LEVANTA CRISTAL ELECTRICAS CON MOTOR



Canal de YouTube - pionero con consejos e instalaciones de productos

LÍNEA LIVIANA

● FIAT	1
● GM	6
● VOLKSWAGEN	12
● FORD	21
● CITROËN	25
● RENAULT	26
● PEUGEOT	28
● HYUNDAI	29
● HONDA	30
● TOYOTA	31
● NISSAN	32

LÍNEA VAN

● FIAT	33
● IVECO	34
● MERCEDES-BENZ	35
● FORD	36
● CITROËN	37
● RENAULT	38
● PEUGEOT	39
● KIA	40
● HYUNDAI	41
● GM	42
● VOLKSWAGEN	43

LÍNEA PICK-UP

● GM	44
● VOLKSWAGEN	46
● FORD	47
● TOYOTA	49
● MITSUBISHI	50
● NISSAN	51
● AGRALE	52

LÍNEA PESADA

● IVECO	53
● MERCEDES-BENZ	54
● SCANIA	57
● VOLVO	58
● GM	59
● VOLKSWAGEN	60
● FORD	62
● HYUNDAI	64
● AGRALE	65
● MARCOPOLO	66
● RANDON	67
PACCAR	68

LÍNEA NÁUTICA

69

MOTORES DE MÁQUINA LEVANTA CRISTAL

Cerradura del maletero - maletero - con llave

F-1209
O&M: 4336147



147 1976 até 1988 incluso modelo Europa, Spazio y Fiorino 147

Cerradura de puerta - delantero - 2 puertas - interna

F-1440D
O&M: 7516181
F-1440E
O&M: 7515950



Duna 1984 até 1995 2P
Elba 1985 até 1996 2P
Uno 1984 até 2010 2P
Uno Fire Economy 2008 até 2013 2P

Cerradura de puerta - delantero - interna

F-1441D
O&M: 7511860
F-1441E
O&M: 5941514



Duna 1984 até 1995 4P
Elba 1985 até 1996 4P
Fiorino 1987 até 2013
Uno 1984 até 2010 4P
Uno Fire Economy 2008 até 2013 4P

Cerradura de puerta - trasero - 4 puertas - interna

F-1415D
O&M: 7526004
F-1415E
O&M: 7526005



Duna 1984 até 1995 4P
Elba 1985 até 1996 4P
Uno 1984 até 2010 4P
Uno Fire Economy 2008 até 2013 4P

MANUAL
Máquina levanta cristal

R-1111
O&M: 4266791

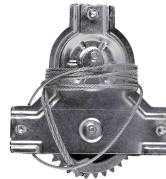

147 1976 até 1988 incluso modelo Europa, Spazio y Fiorino 147
Oggi 1983 até 1986
Panorama 1980 até 1986



MANUAL
Máquina levanta cristal - 2 puertas

R-1420D
O&M: 50006098
R-1420E
O&M: 50006099



Duna 1984 até 1995 2P
Elba 1985 até 1996 2P
Uno 1984 até 2010 2P
Uno Economy 2008 até 2013 2P



MANUAL
Máquina levanta cristal - 4 puertas - delantero

R-1421D 4D
O&M: 50003666
R-1421E 4D
O&M: 50003667



Duna 1984 até 1995 4P
Elba 1985 até 1996 4P
Fiorino 1987 até 2013
Uno 1984 até 2010 4P
Uno Economy 2008 até 2013 4P



MANUAL
Máquina levanta cristal - trasero

R-1421D 4T
O&M: 50003668
R-1421E 4T
O&M: 50003669



Duna 1984 até 1995 4P
Elba 1985 até 1996 4P
Uno 1984 até 2010 4P
Uno Economy 2008 até 2013 4P



MANUAL
Máquina levanta cristal - 2 puertas

R-1416D
O&M: 51835881
R-1416E
O&M: 51835882



Fiorino 2014 em diante
Uno 2011 em diante Vivace / Way / Sporting 2P



MANUAL
Máquina levanta cristal - 4 puertas - delantero

R-1417D
O&M: 51835597
R-1417E
O&M: 51835878



Uno 2010 em diante Vivace / Way / Sporting 4P



MANUAL
Máquina levanta cristal - 4 puertas - trasero

R-1418D
O&M: 51835879
R-1418E
O&M: 51835880



Uno 2010 em diante Vivace / Way / Sporting 4P



MANUAL
Máquina levanta cristal - 2 puertas

R-1437D
O&M: 46446908
R-1437E
O&M: 46446909



Palio 1996 até 2017 2P
Strada 1998 em diante



MANUAL

Máquina levanta cristal - 4 puertas - delantero

R-1438D
O&M: 46446912
R-1438E
O&M: 46446913



Palio 1996 até 2017
Palio Weekend 1997 em diante
Siena 1997 até 2016



MANUAL

Máquina levanta cristal - 4 puertas - trasero

R-1439D
O&M: 46446910
R-1439E
O&M: 46446911



Palio 1996 até 2017 4P
Palio Weekend 1997 em diante
Siena 1997 até 2016



MANUAL

Máquina levanta cristal - 4 puertas - trasero

R-1467D
O&M: 51849103
R-1467E
O&M: 51849107



Grand Siena 2012 em diante
Palio 2012 em diante exceto Fire



MANUAL

Máquina levanta cristal - 2 puertas

R-1442D
O&M: 51720130
R-1442E
O&M: 51720129

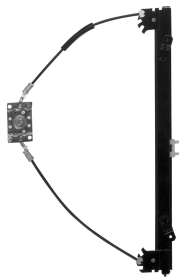

Doblò 2002 em diante



MANUAL

Máquina levanta cristal - 4 puertas - trasero

R-1454D
O&M: 51812480
R-1454E
O&M: 51812479

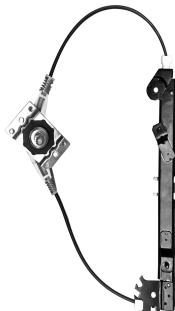

Linea 2008 até 2016
Punto 2007 até 2017



MANUAL

Máquina levanta cristal - 4 puertas - delantero

R-1457D
O&M: 52005758
R-1457E
O&M: 52005756



Mobi 2016 em diante
Strada 2021 em diante cabine simples e dupla



MANUAL

Máquina levanta cristal - 4 puertas - trasero

R-1458D
O&M: 52010304
R-1458E
O&M: 52010303



Mobi 2016 em diante
Strada 2021 em diante cabine dupla



MANUAL

Máquina levanta cristal - 4 puertas - trasero

R-1463D
O&M: 51736258
R-1463E
O&M: 51736260



Idea 2005 até 2016



ELECTRICA - S/MOTOR - motor inverso

Máquina levanta cristal - 4 puertas - delantero - Mabuchi (8 dientes)

R-1433D SM
O&M: 50004955 SM
R-1433E SM
O&M: 50004956 SM



Tempra 1992 até 1999



ELECTRICA - S/MOTOR

Máquina levanta cristal - 2 puertas - Mabuchi (8 dientes)

R-1430D SM
O&M: 7523662 SM
R-1430E SM
O&M: 7523661 SM



Duna 1984 até 1995 2P
Elba 1985 até 1996 2P
Uno 1984 até 2010 2P
Uno Economy 2008 até 2013 2P



ELECTRICA - S/MOTOR - motor inverso

Máquina levanta cristal - 4 puertas - delantero - Mabuchi (8 dientes)

R-1431D SM
O&M: 7524175 SM
R-1431E SM
O&M: 7524176 SM



Duna 1984 até 1995 4P
Elba 1985 até 1996 4P
Fiorino 1987 até 2013
Uno 1984 até 2010 4P
Uno Economy 2008 até 2013 4P



ELECTRICA - S/MOTOR

Máquina levanta cristal - trasero - Mabuchi (8 dientes)

R-1459D SM
O&M: 50003668 SM
R-1459E SM
O&M: 50003669 SM

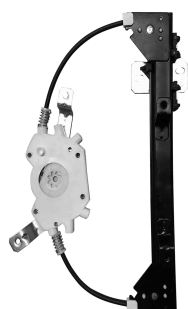

Duna 1984 até 1995
Elba 1985 até 1996
Uno 1984 até 2010
Uno Economy 2008 até 2013



ELECTRICA - S/MOTOR - motor inverso

Máquina levanta cristal - 2 puertas - Mabuchi (8 dientes)

R-1427D SM
O&M: 51835886 SM
R-1427E SM
O&M: 51835887 SM



Fiorino 2014 em diante
Uno 2011 em diante Vivace / Way / Sporting 2P



ELECTRICA - S/MOTOR

Máquina levanta cristal - 4 puertas - delantero - Mabuchi (8 dientes)

R-1428D SM
O&M: 51835884 SM
R-1428E SM
O&M: 51835885 SM



Uno 2010 em diante Vivace / Way / Sporting 4P



ELECTRICA - S/MOTOR - motor inverso

Máquina levanta cristal - 4 puertas - trasero - Mabuchi (8 dientes)

R-1429D SM
O&M: 518358879 SM
R-1429E SM
O&M: 518358880 SM

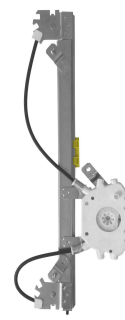

Uno 2010 em diante Vivace / Way / Sporting 4P



ELECTRICA - S/MOTOR

Máquina levanta cristal - 2 puertas - delantero - original (32 estrías)

R-1470D SM
O&M: 51835886
R-1470E SM
O&M: 51835887



Uno Vivace 2010 em diante



ELECTRICA - S/MOTOR

Máquina levanta cristal - 4 puertas - delantero - original (32 estrías)

R-1471D SM
O&M: 51835884
R-1471E SM
O&M: 51835885



Uno Vivace 2010 em diante



ELECTRICA - S/MOTOR

Máquina levanta cristal - 4 puertas - trasero - original (32 estrías)

R-1472D SM
O&M: 51835884
R-1472E SM
O&M: 51835885



Uno Vivace 2010 em diante



ELECTRICA - S/MOTOR - motor inverso

Máquina levanta cristal - 4 puertas - trasero - Mabuchi (8 dientes)

R-1434D SM
O&M: 46446910 SM
R-1434E SM
O&M: 46446911 SM



Palio 1996 até 2017 4P
Palio Weekend 1997 em diante
Siena 1997 até 2016



ELECTRICA - S/MOTOR

Máquina levanta cristal - 2 puertas - Mabuchi (8 dientes)

R-1435D SM
O&M: 51771448 SM
R-1435E SM
O&M: 51772393 SM



Palio 1996 até 2017
Strada 1998 em diante



ELECTRICA - S/MOTOR - motor inverso

Máquina levanta cristal - 4 puertas - delantero - Mabuchi (8 dientes)

R-1436D SM
O&M: 46736842 SM
R-1436E SM
O&M: 46736843 SM



Palio 1996 até 2017
Palio Weekend 1997 em diante
Siena 1997 até 2016



ELECTRICA - S/MOTOR - motor inverso

Máquina levanta cristal - 4 puertas - delantero - Mabuchi (8 dientes)

R-1447D SM
O&M: 51849097 SM
R-1447E SM
O&M: 51849101 SM



Grand Siena 2012 em diante
Palio 2012 em diante exceto Fire



ELECTRICA - S/MOTOR

Máquina levanta cristal - 4 puertas - trasero - Mabuchi (8 dientes)

R-1448D SM
O&M: 51849106 SM
R-1448E SM
O&M: 51849110 SM



Grand Siena 2012 em diante
Palio 2012 em diante exceto Fire



ELECTRICA - S/MOTOR

Máquina levanta cristal - 4 puertas - delantero - original (32 estrías)

R-1468D SM
O&M: 51849097
R-1468E SM
O&M: 51849101



Grand Siena 2012 em diante
Palio 2012 em diante exceto Fire



ELECTRICA - S/MOTOR

Máquina levanta cristal - 4 puertas - trasero - original (32 estrías)

R-1469D SM
O&M: 51849106
R-1469E SM
O&M: 51849110



Grand Siena 2012 em diante
Palio 2012 em diante exceto Fire

ELECTRICA - S/MOTOR - motor inverso

Máquina levanta cristal - 2 puertas - Mabuchi (8 dientes)

R-1443D SM
O&M: 51720132 SM
R-1443E SM
O&M: 51720131 SM



Doblo 2002 em diante

ELECTRICA - S/MOTOR

Máquina levanta cristal - 4 puertas - trasero - Mabuchi (8 dientes)

R-1412D SM
O&M: 52045687 SM
R-1412E SM
O&M: 52045658 SM



Argo 2016 em diante
Cronos 2018 em diante

ELECTRICA - S/MOTOR

Máquina levanta cristal - 4 puertas - delantero - Mabuchi (8 dientes)

R-1461D SM
O&M: 51753953 SM
R-1461E SM
O&M: 51784091 SM



Linea 2008 até 2016
Punto 2007 até 2017

ELECTRICA - S/MOTOR

Máquina levanta cristal - 4 puertas - delantero - original (32 estrías)

R-1462D SM
O&M: 51753953 SM
R-1462E SM
O&M: 51784091 SM



Linea 2008 até 2016
Punto 2007 até 2017

ELECTRICA - S/MOTOR

Máquina levanta cristal - 4 puertas - trasero - Mabuchi (8 dientes)

R-1425D SM
O&M: 51753953 SM
R-1425E SM
O&M: 51784091 SM



Linea 2008 até 2016
Punto 2007 até 2017

ELECTRICA - S/MOTOR

Máquina levanta cristal - 4 puertas - trasero - original (32 estrías)

R-1455D SM
O&M: 51812480
R-1455E SM
O&M: 51812479

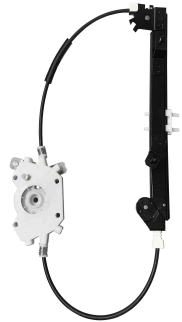

Linea 2008 até 2016
Punto 2007 até 2017

ELECTRICA - S/MOTOR

Máquina levanta cristal - 4 puertas - delantero - original (32 estrías)

R-1465D SM
O&M: 51736134
R-1465E SM
O&M: 51736135



Idea 2005 até 2016

ELECTRICA - S/MOTOR

Máquina levanta cristal - 4 puertas - trasero - original (32 estrías)

R-1466D SM
O&M: 51736259
R-1466E SM
O&M: 51736261



Idea 2005 até 2016

ELECTRICA - S/MOTOR - motor inverso

Máquina levanta cristal - 4 puertas - trasero - Mabuchi (8 dientes)

R-1426D SM
O&M: 51783847 SM
R-1426E SM
O&M: 51783849 SM



Idea 2005 até 2016

ELECTRICA - S/MOTOR

Máquina levanta cristal - 4 puertas - delantero - Mabuchi (8 dientes)

R-1451D SM
O&M: 520005757 SM
R-1451E SM
O&M: 520005759 SM



Mobi 2016 em diante
Strada 2021 em diante cabine simples e dupla

ELECTRICA - S/MOTOR

Máquina levanta cristal - 4 puertas - trasero - Mabuchi (8 dientes)

R-1452D SM
O&M: 52010304 SM
R-1452E SM
O&M: 52010303 SM



Mobi 2016 em diante
Strada 2021 em diante cabine dupla

ELECTRICA - S/MOTOR

Máquina levanta cristal - 4 puertas - original (32 estrías)

R-1473E SM
O&M: 52005759



Mobi 2016 em diante
Strada Nova Geração 2021 em diante



ELECTRICA - S/MOTOR

Máquina levanta cristal - 4 puertas - original (32 estrías)

R-1473D SM
O&M: 52005757



Mobi 2016 em diante
Strada Nova Geração 2021 em diante



ELECTRICA - S/MOTOR

Máquina levanta cristal - 4 puertas - trasero - original (32 estrías)

R-1474D SM
O&M: 52010304
R-1474E SM
O&M: 52010303



Mobi 2016 em diante
Strada Nova Geração

Cerradura de puerta - delantero

F-3355D
O&M: 90452382
F-3355E
O&M: 90452381

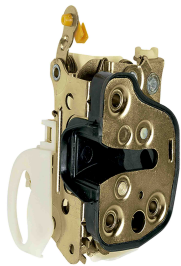

Classic 2004 até 2010
Corsa hatch/sedan/pick-up/wagon 1994 até 2002 2P/4P
Corsa sedan Classic 2002 até 2004

Cerradura de puerta - trasero - 4 puertas

F-3356D
O&M: 90482462
F-3356E
O&M: 90482461



Classic 2004 até 2010
Corsa hatch/sedan/wagon 1994 até 2002 4P
Corsa sedan Classic 2002 até 2004

MANUAL

Máquina levanta cristal - 2 puertas

R-3112D
O&M: 9299582
R-3112E
O&M: 9299581

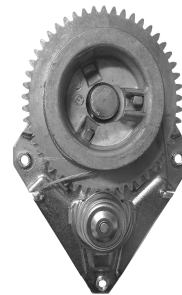

Chevette 1973 até 1982 2P
Marajó 1980 até 1982



MANUAL

Máquina levanta cristal - 2 puertas

R-3112D 83
O&M: 94626686
R-3112E 83
O&M: 94626685

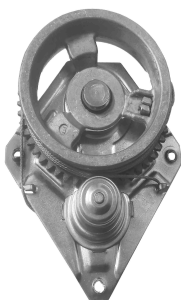

Chevette 1983 até 1993 2P
Chevy 500 1983 até 1995
Marajó 1983 até 1989



MANUAL

Máquina levanta cristal - 4 puertas - delantero

R-3112D 4D
O&M: 94633632
R-3112E 4D
O&M: 94633631



Chevette 1983 até 1986 4P



MANUAL

Máquina levanta cristal - 4 puertas - trasero

R-3112D 4T
O&M: 94633654
R-3112E 4T
O&M: 94633653



Chevette 1983 até 1986 4P



MANUAL

Máquina levanta cristal - 2 puertas

R-3113D
O&M: 7331080
R-3113E
O&M: 7331079



Caravan 1975 até 1992
Opala 1972 até 1988 2P



MANUAL

Máquina levanta cristal - 4 puertas - delantero

R-3113D 4D
O&M: 7323885
R-3113E 4D
O&M: 7323884



Opala 1969 até 1992 4P



MANUAL

Máquina levanta cristal - 4 puertas - trasero

R-3113D 4T
O&M: 7323908
R-3113E 4T
O&M: 7323907



Opala 1969 até 1992 4P



MANUAL

Máquina levanta cristal - 2 puertas - cremallera

R-3322D
O&M: 90035486
R-3322E
O&M: 90035485



Monza 1982 até 1983 2P

MANUAL

Máquina levanta cristal - 2 puertas

R-3320D
O&M: 94649470
R-3320E
O&M: 94649469



Monza 1983 até 1996 2P

MANUAL

Máquina levanta cristal - 4 puertas - delantero

R-3115D
O&M: 90035196
R-3115E
O&M: 90035195



Monza Sedan 1985 até 1996 4P

MANUAL

Máquina levanta cristal - 2 puertas

R-3324D
O&M: 52280828
R-3324E
O&M: 52280827



Ipanema 1989 até 1998
Kadett 1989 até 1998

MANUAL

Máquina levanta cristal - 2 puertas - pin bajo

R-3336D
O&M: 93260866
R-3336E
O&M: 93260865



Fun 2000 até 2006 2P

MANUAL

Máquina levanta cristal - 2 puertas/4 puertas - delantero - pin bajo

R-3339D
O&M: 93363824
R-3339E
O&M: 93363825



Fun 2000 até 2006 2P
Prisma 2006 até 2006 4P

MANUAL

Máquina levanta cristal - 4 puertas - trasero - pin bajo

R-3392D
O&M: 93363560
R-3392E
O&M: 93363859



Fun 2002 até 2006 4P

MANUAL

Máquina levanta cristal - 2 puertas - pin alto

R-3338D
O&M: 93373222
R-3338E
O&M: 93373221



Fun 2007 até 2016 2P

MANUAL

Máquina levanta cristal - 4 puertas - delantero - pin alto

R-3350D
O&M: 93372630
R-3350E
O&M: 93372629



Fun 2006 até 2016 2P/4P
Prisma 2006 até 2012

MANUAL

Máquina levanta cristal - 4 puertas - trasero - pin alto

R-3393D
O&M: 93372639
R-3393E
O&M: 93372638



Fun 2002 até 2006 4P

MANUAL

Máquina levanta cristal - 2 puertas

R-3342D
O&M: 90388866
R-3342E
O&M: 90388865



Corsa 1994 até 2001 2P e Pick-up

MANUAL

Máquina levanta cristal - 4 puertas - delantero

R-3343D
O&M: 90388862
R-3343E
O&M: 90388861



Classic 2004 até 2016
Corsa 1995 até 2001 4P

MANUAL

Máquina levanta cristal - 4 puertas - trasero

R-3348D
O&M: 90389536
R-3348E
O&M: 90389535



Classic 2004 até 2016
Corsa 1995 até 2001 4P

MANUAL

Máquina levanta cristal - 4 puertas - delantero

R-3337D
O&M: 93382280
R-3337E
O&M: 93382279



Corsa 2002 até 2012 4P
Montana 2003 até 2010 2P

MANUAL

Máquina levanta cristal - 4 puertas - trasero

R-3389D
O&M: 9114706
R-3389E
O&M: 9114705



Corsa 2002 até 2012 4P

GM

MANUAL

Máquina levanta cristal - 4 puertas - delantero

R-3318D
O&M: 94700284
R-3318E
O&M: 94700283



Agile 2009 até 2014
Montana 2011 em diante G2

MANUAL

Máquina levanta cristal - 4 puertas - trasero

R-3319D
O&M: 94700281
R-3319E
O&M: 94700282



Agile 2009 até 2014

ELECTRICA - S/MOTOR

Máquina levanta cristal - 2 puertas - M.Carto (oblongo)

R-3330D SM
O&M: 94649144 SM
R-3330E SM
O&M: 94649143 SM



Monza 1983 até 1996 2P

ELECTRICA - S/MOTOR - motor inverso

Máquina levanta cristal - 2 puertas - Mabuchi (8 dientes)

R-3331D SM
O&M: 94649144 SM
R-3331E SM
O&M: 94649143 SM



Monza 1983 até 1996 2P

ELECTRICA - S/MOTOR - motor inverso

Máquina levanta cristal - 4 puertas - delantero - Mabuchi (8 dientes)

R-3329D SM
O&M: 52255182 SM
R-3329E SM
O&M: 52255181 SM

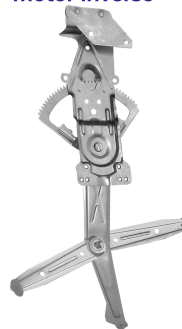

Monza 1984 até 1996 4P inclusive Tubarão

ELECTRICA - S/MOTOR - motor inverso

Máquina levanta cristal - 2 puertas - Mabuchi (8 dientes)

R-3323D SM
O&M: 52280830 SM
R-3323E SM
O&M: 52280829 SM



Ipanema 1989 até 1998
Kadett 1989 até 1998

ELECTRICA - S/MOTOR - motor inverso

Máquina levanta cristal - 2 puertas - Mabuchi (8 dientes)

R-3325D SM
O&M: 93361654 SM
R-3325E SM
O&M: 93361653 SM

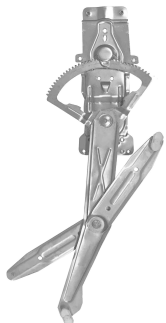

Fun 2000 até 2016 2P

ELECTRICA - S/MOTOR

Máquina levanta cristal - 2 puertas - Bosch (8 dientes)

R-3370D SM
O&M: 93361654 SM
R-3370E SM
O&M: 93361653 SM

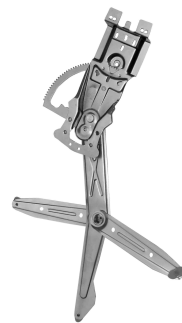

Fun 2000 até 2016 2P

ELECTRICA - S/MOTOR

Máquina levanta cristal - 2 puertas - Bosch (10 dientes)

R-3376D SM
O&M: 93361654 SM
R-3376E SM
O&M: 93361653 SM



Fun 2000 até 2016 2P

ELECTRICA - S/MOTOR - motor inverso

Máquina levanta cristal - 4 puertas - delantero - Mabuchi (8 dientes)

R-3326D SM
O&M: 93324534 SM
R-3326E SM
O&M: 93324533 SM



Fun 2002 até 2016 4P
Prisma 2006 até 2012

ELECTRICA - S/MOTOR

Máquina levanta cristal - 4 puertas - delantero - Bosch (8 dientes)

R-3371D SM
O&M: 93324534 SM
R-3371E SM
O&M: 93324533 SM



Fun 2002 até 2016 4P
Prisma 2006 até 2012

ELECTRICA - S/MOTOR

Máquina levanta cristal - 4 puertas - delantero - Bosch (10 dientes)

R-3377D SM
O&M: 93361653 SM
R-3377E SM
O&M: 93361654 SM



Fun 2002 até 2016 4P
Prisma 2006 até 2012

GM

ELECTRICA - S/MOTOR - motor inverso

Máquina levanta cristal - 4 puertas - trasero - Mabuchi (8 dientes)

R-3351D SM
O&M: 93363860 SM
R-3351E SM
O&M: 93363859 SM

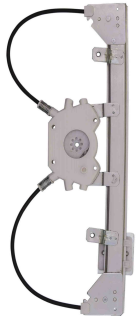

Fun 2002 até 2016 4P

ELECTRICA - S/MOTOR - motor inverso

Máquina levanta cristal - 2 puertas - Mabuchi (8 dientes)

R-3340D SM
O&M: 93334692 SM
R-3340E SM
O&M: 93334693 SM



Corsa 1994 até 2001 2P e Pick-up

ELECTRICA - S/MOTOR

Máquina levanta cristal - 2 puertas - Bosch (8 dientes)

R-3372D SM
O&M: 93334692 SM
R-3372E SM
O&M: 93334693 SM



Corsa 1994 até 2001 2P e Pick-up

ELECTRICA - S/MOTOR - motor inverso

Máquina levanta cristal - 4 puertas - delantero - Mabuchi (8 dientes)

R-3341D SM
O&M: 93334688 SM
R-3341E SM
O&M: 93334689 SM



Classic 2004 até 2016
Corsa 1995 até 2001 4P

ELECTRICA - S/MOTOR

Máquina levanta cristal - 4 puertas - delantero - Bosch (8 dientes)

R-3373D SM
O&M: 93334688 SM
R-3373E SM
O&M: 93334689 SM



Classic 2004 até 2016
Corsa 1995 até 2001 4P

ELECTRICA - S/MOTOR

Máquina levanta cristal - 4 puertas - delantero - Bosch (10 dientes)

R-3378D SM
O&M: 93334688 SM
R-3378E SM
O&M: 93334689 SM



Classic 2004 até 2016
Corsa 1995 até 2001 4P

ELECTRICA - S/MOTOR - motor inverso

Máquina levanta cristal - 4 puertas - trasero - Mabuchi (8 dientes)

R-3349D SM
O&M: 93253442 SM
R-3349E SM
O&M: 93253441 SM



Corsa 1995 até 2001

ELECTRICA - S/MOTOR - motor inverso

Máquina levanta cristal - 4 puertas - delantero - Mabuchi (8 dientes)

R-3327D SM
O&M: 93264210 SM
R-3327E SM
O&M: 93264209 SM

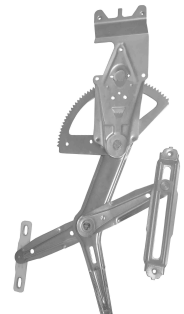

Corsa 2002 até 2012 4P
Montana 2003 até 2010

ELECTRICA - S/MOTOR

Máquina levanta cristal - 2 puertas/4 puertas - delantero - Bosch (8 dientes)

R-3374D SM
O&M: 93264210 SM
R-3374E SM
O&M: 93264209 SM



Corsa 2002 até 2012 4P
Montana 2003 até 2010

ELECTRICA - S/MOTOR

Máquina levanta cristal - 4 puertas - delantero - Bosch (10 dientes)

R-3379D SM
O&M: 93264210 SM
R-3379E SM
O&M: 93264209 SM

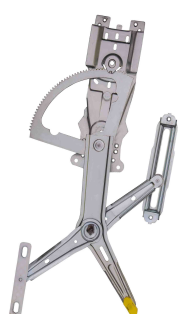

Corsa 2002 até 2012 4P
Montana 2003 até 2010

ELECTRICA - S/MOTOR

Máquina levanta cristal - 4 puertas - trasero - Mabuchi (8 dientes)

R-3328D SM
O&M: 93264214 SM
R-3328E SM
O&M: 93264213 SM



Corsa 2002 até 2012 4P

ELECTRICA - S/MOTOR

Máquina levanta cristal - 2 puertas/4 puertas - delantero - Mabuchi (8 dientes)

R-3334D SM
O&M: 94704762 SM
R-3334E SM
O&M: 94704761 SM



Agile 2009 até 2014
Montana 2011 em diante G2

ELECTRICA - S/MOTOR - motor inverso

Máquina levanta cristal - 4 puertas - trasero - Mabuchi (8 dientes)

R-3335D SM
O&M: 94700280 SM
R-3335E SM
O&M: 94700279 SM



Agile 2009 até 2014

ELECTRICA - S/MOTOR

Máquina levanta cristal - 4 puertas - delantero - Bosch (10 dientes)

R-3364D SM
O&M: 93329517 SM
R-3364E SM
O&M: 93329516 SM



Vectra 1997 até 2005

ELECTRICA - S/MOTOR

Máquina levanta cristal - 4 puertas - delantero - Bosch (10 dientes)

R-3365D SM
O&M: 93306469 SM
R-3365E SM
O&M: 93306468 SM



Vectra 2006 até 2011

ELECTRICA - S/MOTOR

Máquina levanta cristal - 2 puertas/4 puertas - delantero - original (10 dientes)

R-3366D SM
O&M: 9325506493326100 SM
R-3366E SM
O&M: 9325506393326100 SM

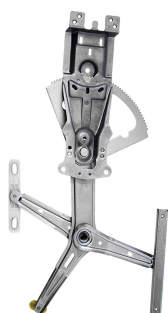

Astra hatch/sedan 1999 até 2001 2P/4P

ELECTRICA - S/MOTOR

Máquina levanta cristal - 4 puertas - trasero - Mabuchi (8 dientes)

R-3390D SM
R-3390E SM



Astra hatch 2003 até 2011
Astra sedan 1999 até 2011



ELECTRICA - S/MOTOR

Máquina levanta cristal - 4 puertas - trasero - original (10 dientes)

R-3391D SM
O&M: 93255066 SM
R-3391E SM
O&M: 93255065 SM



Astra hatch 2003 até 2011
Astra sedan 1999 até 2011



ELECTRICA - S/MOTOR

Máquina levanta cristal - 4 puertas - delantero - Bosch (10 dientes)

R-3375D SM
O&M: 93281522 SM
R-3375E SM
O&M: 93281521 SM

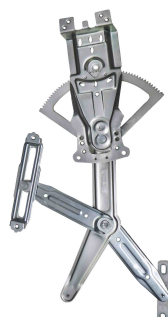

Zafira 2001 até 2012



ELECTRICA - S/MOTOR

Máquina levanta cristal - 4 puertas - delantero - Mabuchi (8 dientes)

R-3352D SM
O&M: 94773654 SM
R-3352E SM
O&M: 94773653 SM



Cobalt 2011 em diante



ELECTRICA - S/MOTOR - motor inverso

Máquina levanta cristal - 4 puertas - trasero - Mabuchi (8 dientes)

R-3353D SM
O&M: 94773650 SM
R-3353E SM
O&M: 94773649 SM



Cobalt 2011 em diante

ELECTRICA - S/MOTOR

Máquina levanta cristal - 4 puertas - delantero - Mabuchi (8 dientes)

R-3359D SM
O&M: 52039028 SM
R-3359E SM
O&M: 52039029 SM



Onix 2012 em diante
Prisma 2013 em diante



ELECTRICA - S/MOTOR

Máquina levanta cristal - 4 puertas - trasero - Mabuchi (8 dientes)

R-3360D SM
O&M: 52039027 SM
R-3360E SM
O&M: 52039026 SM



Onix 2012 em diante
Prisma 2013 em diante

ELECTRICA - S/MOTOR

Máquina levanta cristal - 4 puertas - delantero - Mabuchi (8 dientes)

R-3361D SM
O&M: 52021149 SM
R-3361E SM
O&M: 52021151 SM



Spin 2012 em diante

ELECTRICA - S/MOTOR

Máquina levanta cristal - 4 puertas - trasero - Mabuchi (8 dientes)

R-3362D SM
O&M: 52211166 SM
R-3362E SM
O&M: 52211164 SM



Spin 2012 em diante

Motor de máquina levanta cristal - original (32 estrías) - 12v

M-6705D
O&M: 94773649
M-6705E
O&M: 94773650



Cobalt 2011 em diante
Spin 2012 em diante

Cerradura de puerta

C-4200D
O&M: 111837022Z
C-4200E
O&M: 111837021Z



Sedan 1200, 1300 e 1500 1959 até 1977

Cerradura de puerta

F-4201D
O&M: 111837016Z
F-4201E
O&M: 111837015Z



Sedan 1200, 1300 e 1500 1959 até 1977

Cierre del capot - inferior

F-4203I
O&M: 111823509B



Sedan 1300, 1500 e 1600 1971 até 1981

Cierre del capot - superior

F-4203S
O&M: 111823507F



Sedan 1300, 1500 e 1600 1971 até 1981

Cierre del capot - inferior

F-4204I
O&M: 152823509B

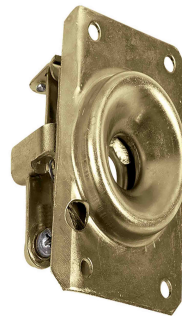

Sedan Mexicano 1971 em diante

Cerradura de puerta

F-4207D
O&M: 102837016I
F-4207E
O&M: 102837015I

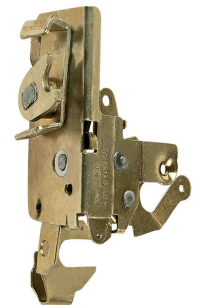

Brasília 1973 até 1982
Sedan 1978 até 1996
Variant 1978 até 1982

Cerradura de puerta - central - de la porta del medio - con traba

F-421I
O&M: 211841605I



Kombi Clipper 1976 até 1996

Cerradura del maletero - tapa

F-4202T
O&M: 231829211I

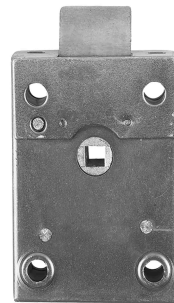

Kombi 1957 até 1996

Cerradura del maletero - tapa

F-4206T
O&M: 211829211H



Kombi 1997 até 2014

Cerradura de puerta - central - de la porta del medio - con enganche (gancho)

F-4213
O&M: 211843604J



Kombi 1997 até 2014

Cerradura de puerta - central - de la porta del medio - con traba - con manija

F-4205
O&M: 211843654

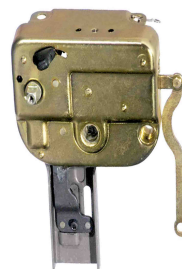

Kombi 1997 até 2014

Cerradura de puerta - delantero

F-4498D
O&M: 231837016I
F-4498E
O&M: 231837015I



Kombi Clipper 1976 até 1996
Worker / Titan / Tractor 1980 em diante

Cerradura de puerta -
delantero -
2 puertas/4 puertas

F-4493D
O&M: 3058370163
F-4493E
O&M: 3058370153



Gol 1000 1992 até 1996
Gol 1988 até 1994
Parati 1988 até 1995
Santana 1984 até 1990 2P/4P
Santana Quantum 1984 até 1990
Saveiro 1988 até 1997
Voyage 2P/4P

Cerradura de puerta -
trasero -
2 puertas/4 puertas

F-4495D
O&M: ZBD839016
F-4495E
O&M: ZBD839015



Santana 1984 até 1990 4P
Santana Quantum 1984 até 1990

Cerradura de puerta

F-4395D
O&M: 3058370161
F-4395E
O&M: 3058370151



Gol 1980 até 1987
Parati 1982 até 1987
Saveiro 1982 até 1987
Voyage 1981 até 1987 2P

Cerradura de puerta

F-4587D
O&M: 3058370165
F-4587E
O&M: 3058370155



Gol 1000 1992 até 1996
Gol 1988 até 1994
Parati 1988 até 1995
Santana 1984 até 1990 2P/4P
Santana Quantum 1984 até 1990
Saveiro 1988 até 1997
Voyage 2P/4P

Cerradura de puerta -
manual - 2 puertas

F-4588D
O&M: 377837016
F-4588E
O&M: 377837015



Gol 1995 até 1999 2P
Gol Special Bola 1998 até 2005 2P
Parati 1996 até 1999 2P

Cerradura de puerta -
manual - delantero

F-4589D
O&M: 373837013B999
F-4589E
O&M: 373837014B999



Gol 1998 até 1999 4P
Parati 1997 até 1999 4P
Saveiro 1998 até 1999

Cerradura de puerta -
manual - delantero

F-4590D
O&M: 5W4837014AC
F-4590E
O&M: 5W4837013AA



Gol G3/G4 2000 até 2008 4P
Gol G4 - no cabe en G5 2009 até 2014 4P
Parati G3/G4 2000 até 2013
Saveiro G3/G4 2000 até 2009

Cerradura de puerta -
manual - 2 puertas

F-4591D
O&M: 5W3837014B
F-4591E
O&M: 5W3837013B



Gol G3/G4 2000 até 2014 2P

Cerradura de puerta -
manual - 2 puertas -
mod.Maxion

F-4592D
O&M: 373837014
F-4592E
O&M: 373837013



Gol G3/G4 2000 até 2014 2P

Marco ventilete

M-41001D
O&M: 111831176
M-41001E
O&M: 111831175



Sedan 1959 até 1996

MANUAL

Máquina levanta
cristal - 2 puertas

R-4170D
O&M: 1028375021
R-4170E
O&M: 1028375011

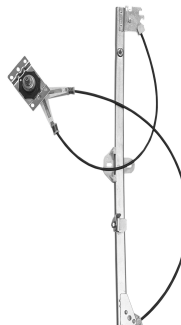

Brasília 1973 até 1982



MANUAL

Máquina levanta
cristal - 2 puertas

R-4107D
O&M: 111837502ZB
R-4107E
O&M: 111837501ZB



Sedan 1959 até 1970

MANUAL

Máquina levanta cristal - 2 puertas



R-4108D
O&M: 1138375021
R-4108E
O&M: 1138375011

Sedan 1971 até 1996

MANUAL

Máquina levanta cristal - 2 puertas



R-4109D
O&M: 1318375021
R-4109E
O&M: 1318375011

Variant 1970 até 1977

MANUAL

Máquina levanta cristal - 2 puertas/4 puertas



R-4110D
O&M: ZBA837400
R-4110E
O&M: ZBA837399

Passat 1974 até 1981

MANUAL

Máquina levanta cristal - 2 puertas - pin bajo - fijado con remache



R-4171D
O&M: 2118375021
R-4171E
O&M: 2118375011

Kombi 1976 até 2007



MANUAL

Máquina levanta cristal - pin bajo - fijado con tornillos M6x10mm



R-4405D
O&M: 2118375021
R-4405E
O&M: 2118375011

Kombi 1976 até 2007



MANUAL

Máquina levanta cristal - 2 puertas - pin alto



R-4099D
O&M: 7X0837502
R-4099E
O&M: 7X0837501

Kombi 2008 até 2014



MANUAL

Máquina levanta cristal - 2 puertas/4 puertas - delantero



R-4184D
O&M: ZBC837502D
R-4184E
O&M: ZBC837501E

Royale 1992 até 1996
Santana 1984 até 1998
Santana Quantum 1984 até 1998
Versailles 1991 até 1996



MANUAL

Máquina levanta cristal - 4 puertas - trasero



R-4185D
O&M: ZBC839502D
R-4185E
O&M: ZBD839501E

Royale 1992 até 1996
Santana 1984 até 1998
Santana Quantum 1984 até 1998
Versailles 1991 até 1996



MANUAL

Máquina levanta cristal - 4 puertas - delantero



R-4186D
O&M: 3278375022
R-4186E
O&M: 3278375012

Santana 1999 até 2002
Santana Quantum 1999 até 2002



MANUAL

Máquina levanta cristal - 4 puertas - trasero



R-4187D
O&M: 3278395028
R-4187E
O&M: 3278395018

Santana 1999 até 2002
Santana Quantum 1999 até 2002



MANUAL

Máquina levanta cristal - 2 puertas - pin bajo

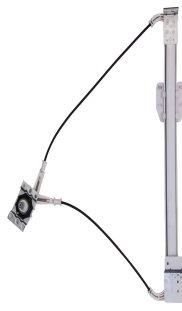

R-4105D
O&M: 3058375024
R-4105E
O&M: 3058375014

Gol 1980 até 1986
Parati 1982 até 1986
Saveiro 1982 até 1986
Voyage 1981 até 1986 2P



MANUAL

Máquina levanta cristal - 2 puertas - pin alto



R-4106D
O&M: 3078375021
R-4106E
O&M: 3078375011

Gol 1000 1992 até 1996
Gol 1987 até 1994
Parati 1987 até 1995
Saveiro 1987 até 1997
Voyage 1987 até 1995 2P



MANUAL

Máquina levanta cristal - 2 puertas

R-4104D
O&M: 373839502
R-4104E
O&M: 373839501



Gol 1995 até 1999 2P Bola
Gol Special 1998 até 2005 2P Bola
Parati 1996 até 1999 2P Bola



MANUAL

Máquina levanta cristal - 2 puertas

R-4100D
O&M: 5XO837502
R-4100E
O&M: 5XO837501



Gol Special 2001 até 2014 G3/G4



MANUAL

Máquina levanta cristal - 4 puertas - delantero - sube la ventana en el sentido antihorario

R-4175D
O&M: 373837502
R-4175E
O&M: 373837501



Gol 1998 até 2014 4P Bola, G3 e G4
Parati 1997 até 2013 4P Bola, G3 e G4
Saveiro 1998 até 2010 Bola, G3 e G4



MANUAL

Máquina levanta cristal - 4 puertas - delantero - sube la ventana en el sentido horario

R-4179D
R-4179E



Gol 1998 até 2014 4P Bola, G3 e G4
Parati 1997 até 2013 4P Bola, G3 e G4
Saveiro 1998 até 2010 Bola, G3 e G4



MANUAL

Máquina levanta cristal - 4 puertas - trasero

R-4177D
O&M: 373839502
R-4177E
O&M: 373839501



Gol 1998 até 2014 Bola, G3 e G4
Parati 1997 até 2013 Bola, G3 e G4



MANUAL

Máquina levanta cristal - 2 puertas

R-4394D
O&M: 5U3837402
R-4394E
O&M: 5U3837401



Gol nov/2012 em diante G5, G6 e G7
Saveiro 2010 em diante G5, G6 e G7



MANUAL

Máquina levanta cristal - 4 puertas - delantero

R-4392D
O&M: 5U4837402
R-4392E
O&M: 5U4837401



Gol jun/2008 em diante G5, G6 e G7
Voyage 2008 em diante G5, G6 e G7



MANUAL

Máquina levanta cristal - 4 puertas - trasero

R-4393D
O&M: 5U4839402A
R-4393E
O&M: 5U4839401A



Gol jun/2008 em diante G5, G6 e G7
Voyage 2008 em diante G5, G6 e G7



MANUAL

Máquina levanta cristal - 4 puertas - delantero - pin bajo

R-4101D 4D
O&M: 3028375022
R-4101E 4D
O&M: 3028375012

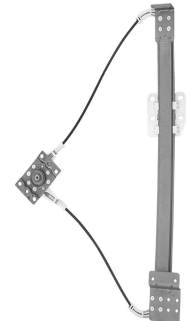

Voyage 1982 até 1987 4P

MANUAL

Máquina levanta cristal - 4 puertas - delantero - pin alto

R-4103D 4D
O&M: 3028375027
R-4103E 4D
O&M: 3028375017



Voyage 1988 até 1996 4P argentino

MANUAL

Máquina levanta cristal - 2 puertas

R-4172D
O&M: 547837502B
R-4172E
O&M: 547837501B



Escort 1993 até 1996
Logus 1993 até 1997



MANUAL

Máquina levanta cristal - 4 puertas - delantero

R-5216D
O&M: 95ABA23201AA
R-5216E
O&M: 95ABA23202AA



Escort Hatch/Sedan/Wagon 1997 até 2003
Pointer 1994 até 1996



VOLKSWAGEN

MANUAL

Máquina levanta cristal - 4 puertas - trasero

R-5250D
O&M: 95ABA2700AA
R-5250E
O&M: 95ABA2700AA



Escort hatch 1997 até 2003
Escort sedan 1997 até 1998
Escort SW 1997 até 2003
Pointer 1994 até 1996
Verona 1993 até 1996



MANUAL

Máquina levanta cristal - 2 puertas - pin bajo

R-4396D
O&M: 5Z3837502E
R-4396E
O&M: 5Z3837501E

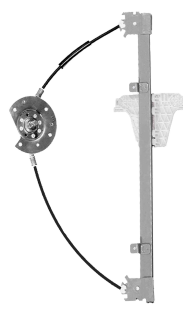

Fox 2003 até set/2009 2P



MANUAL

Máquina levanta cristal - 4 puertas - delantero - pin bajo

R-4397D
O&M: 5Z4837402D
R-4397E
O&M: 5Z4837401D

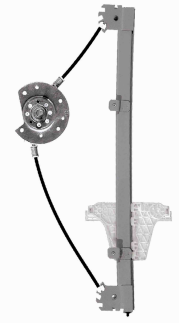

Fox 2003 até set/2009 4P
SpaceFox 2006 até set/2009



MANUAL

Máquina levanta cristal - 4 puertas - trasero - pin bajo

R-4398D
O&M: 5Z4839402
R-4398E
O&M: 5Z4839401

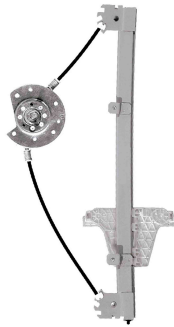

Fox 2003 até set/2009
SpaceFox 2006 até set/2009



MANUAL

Máquina levanta cristal - 2 puertas - pin alto

R-4399D
O&M: 5Z3837502G
R-4399E
O&M: 5Z3837501G



Fox out/2009 em diante 2P



MANUAL

Máquina levanta cristal - 4 puertas - delantero - pin alto

R-4400D
O&M: 5Z4837402G
R-4400E
O&M: 5Z4837401G

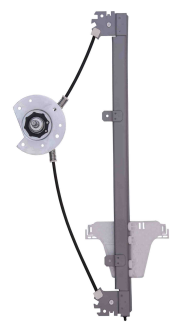

Fox out/2009 em diante 4P



MANUAL

Máquina levanta cristal - 4 puertas - trasero - pin alto

R-4401D
O&M: 5Z4839402D
R-4401E
O&M: 5Z4839401D

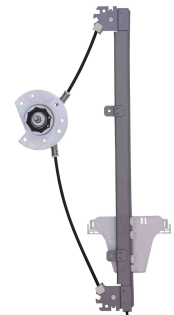

Fox out/2009 em diante



MANUAL

Máquina levanta cristal - 2 puertas

R-4197D
O&M: 111837502F
R-4197E
O&M: 111837501F



Sedan Americano

MANUAL

Máquina levanta cristal - 2 puertas

R-4167D
O&M: 111837502H
R-4167E
O&M: 111837501H



Sedan Alemão 1968 até 1974

MANUAL

Máquina levanta cristal - 2 puertas

R-4164D
O&M: 111837502K
R-4164E
O&M: 111837501K



Sedan Mexicano 1972 em diante

ELECTRICA - S/MOTOR - motor inverso

Máquina levanta cristal - 2 puertas - Mabuchi (8 dientes)

R-4120D SM
O&M: 1138375021 SM
R-4120E SM
O&M: 1138375011 SM



Sedan 1971 até 1996

ELECTRICA - S/MOTOR

Máquina levanta cristal - 2 puertas - Mabuchi (8 dientes) - nacional

R-4119D SM
O&M: ZBA837400 SM
R-4119E SM
O&M: ZBA837399 SM



Passat 1974 até 1981

VOLKSWAGEN

ELECTRICA - S/MOTOR

Máquina levanta cristal - 2 puertas - Mabuchi (8 dientes)

R-4176D SM
O&M: 2118375021 SM
R-4176E SM
O&M: 2118375011 SM



Kombi 1976 até 2014

ELECTRICA - S/MOTOR - motor inverso

Máquina levanta cristal - 2 puertas/4 puertas - delantero - Mabuchi (8 dientes)

R-4190D SM
O&M: ZBC837502A SM
R-4190E SM
O&M: ZBC837501A SM



Royale 1992 até 1996
Santana 1984 até 1998
Santana Quantum 1984 até 1998
Versailles 1991 até 1996

ELECTRICA - S/MOTOR

Máquina levanta cristal - 2 puertas/4 puertas - delantero - M.Cartó (oblongo)

R-4193D SM
O&M: 3278375025 SM
R-4193E SM
O&M: 3278375015 SM



Santana 1984 até 1998
Santana Quantum 1984 até 1998

ELECTRICA - S/MOTOR - motor inverso

Máquina levanta cristal - 4 puertas - delantero - Mabuchi (8 dientes)

R-4191D SM
O&M: 3278375023 SM
R-4191E SM
O&M: 3278375013 SM



Santana 1999 até 2006
Santana Quantum 1999 até 2002

ELECTRICA - S/MOTOR - motor inverso

Máquina levanta cristal - 4 puertas - trasero - Mabuchi (8 dientes)

R-4192D SM
O&M: ZBD839502A SM
R-4192E SM
O&M: ZBD839501A SM



Santana 1999 até 2006
Santana Quantum 1999 até 2002

ELECTRICA - S/MOTOR

Máquina levanta cristal - 4 puertas - trasero - M.Cartó (oblongo)

R-4194D SM
O&M: 3278395025 SM
R-4194E SM
O&M: 3278395015 SM



Santana 1984 até 1998
Santana Quantum 1984 até 1998

ELECTRICA - S/MOTOR

Máquina levanta cristal - 2 puertas - M.Cartó (oblongo)

R-4130D SM
O&M: 3058375025 SM
R-4130E SM
O&M: 3058375015 SM



Gol 1980 até 1994
Parati 1982 até 1995
Saveiro 1982 até 1997
Voyage 1981 até 1995 2P

ELECTRICA - S/MOTOR

Máquina levanta cristal - 2 puertas - Mabuchi (8 dientes)

R-4131D SM
O&M: 3058375025 SM
R-4131E SM
O&M: 3058375015 SM

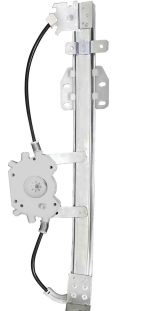

Gol 1000 1992 até 1996
Gol 1980 até 1994
Parati 1982 até 1996
Saveiro 1982 até 1997
Voyage 1981 até 1996

ELECTRICA - S/MOTOR

Máquina levanta cristal - 2 puertas - Mabuchi (8 dientes)

R-4132D SM
O&M: 377837502A SM
R-4132E SM
O&M: 377837501A SM



Gol 1995 até 1999 2P Bola
Parati 1996 até 1999 2P Bola

ELECTRICA - S/MOTOR

Máquina levanta cristal - 2 puertas - Mabuchi (8 dientes)

R-4129D SM
O&M: 5X0837502A SM
R-4129E SM
O&M: 5X0837501A SM



Gol Special 2001 até 2014 G3/G4

ELECTRICA - S/MOTOR - motor inverso

Máquina levanta cristal - 4 puertas - delantero - Mabuchi (8 dientes)

R-4174D SM
O&M: 373837502B SM
R-4174E SM
O&M: 373837501B SM



Gol 1998 até 2014 4P Bola, G3 e G4
Parati 1997 até 2013 4P Bola, G3 e G4
Saveiro 1998 até 2010 Bola, G3 e G4

ELECTRICA - S/MOTOR

Máquina levanta cristal - 4 puertas - delantero - original (10 dientes)

R-4139D SM
O&M: 373837502B
R-4139E SM
O&M: 373837501B



Gol 1998 até 2014 4P Bola, G3 e G4
Parati 1997 até 2013 4P Bola, G3 e G4
Saveiro 1998 até 2010 Bola, G3 e G4

ELECTRICA - S/MOTOR - motor inverso

Máquina levanta cristal - trasero - Mabuchi (8 dientes)

R-4189D SM
O&M: 373839502B SM
R-4189E SM
O&M: 373839501B SM

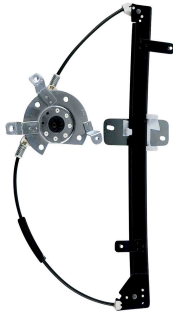

Gol 1998 até 2014 Bola, G3 e G4
Parati 1997 até 2013 Bola, G3 e G4



ELECTRICA - S/MOTOR

Máquina levanta cristal - 4 puertas - trasero - original (10 dientes)

R-4140D SM
O&M: 373839501
R-4140E SM
O&M: 373839502



Gol 1998 até 2014 Bola, G3 e G4
Parati 1997 até 2013 Bola, G3 e G4



ELECTRICA - S/MOTOR

Máquina levanta cristal - 2 puertas - Mabuchi (8 dientes)

R-4135D SM
O&M: 5U3837400 SM
R-4135E SM
O&M: 5U3837399 SM



Gol nov/2012 em diante G5, G6 e G7
Saveiro cabina simples 2010 em diante G5, G6 e G7



ELECTRICA - S/MOTOR

Máquina levanta cristal - 2 puertas - Bosch (32 estrías)

R-4138D SM
O&M: 5U3837400 SM
R-4138E SM
O&M: 5U3837399 SM



Gol nov/2012 em diante G5, G6 e G7
Saveiro cabina simples 2010 em diante G5, G6 e G7



ELECTRICA - S/MOTOR

Máquina levanta cristal - 4 puertas - delantero - Mabuchi (8 dientes)

R-4133D SM
O&M: 5U4837400 SM
R-4133E SM
O&M: 5U4837399 SM



Gol jun/2008 em diante G5, G6 e G7
Saveiro cabina extendida 2010 em diante G5, G6 e G7
Voyage 2008 em diante G5, G6 e G7



ELECTRICA - S/MOTOR

Máquina levanta cristal - 4 puertas - delantero - Bosch (32 estrías)

R-4136D SM
O&M: 5U4837400 SM
R-4136E SM
O&M: 5U4837399 SM

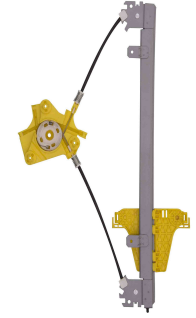

Gol jun/2008 em diante G5, G6 e G7
Voyage 2008 em diante G5, G6 e G7



ELECTRICA - S/MOTOR

Máquina levanta cristal - 4 puertas - trasero - Mabuchi (8 dientes)

R-4134D SM
O&M: 5U4839400A SM
R-4134E SM
O&M: 5U4839399A SM



Gol jun/2008 em diante G5, G6 e G7
Voyage 2008 em diante G5, G6 e G7



ELECTRICA - S/MOTOR

Máquina levanta cristal - 4 puertas - trasero - Bosch (32 estrías)

R-4137D SM
O&M: 5U4839400A SM
R-4137E SM
O&M: 5U4839399A SM

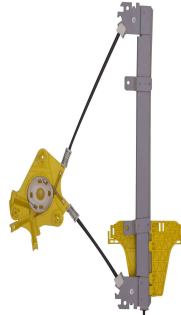

Gol jun/2008 em diante G5, G6 e G7
Voyage 2008 em diante G5, G6 e G7



ELECTRICA - S/MOTOR

Máquina levanta cristal - 2 puertas - Mabuchi (8 dientes)

R-4173D SM
O&M: 547837502D SM
R-4173E SM
O&M: 547837501D SM



Escort 1993 até 1996
Logus 1993 até 1997



ELECTRICA - S/MOTOR

Máquina levanta cristal - 4 puertas - delantero - Mabuchi (8 dientes)

R-5230D SM
O&M: 97AGA23200AA SM
R-5230E SM
O&M: 97AGA23201AA SM



Escort Hatch/Sedan/Wagon 1997 até 2003
Pointer 1994 até 1996
Verona 1994 até 1996



ELECTRICA - S/MOTOR

Máquina levanta cristal - 4 puertas - trasero - Mabuchi (8 dientes)

R-5232D SM
O&M: 97AGA27000BA SM
R-5232E SM
O&M: 97AGA27001BA SM



Escort Hatch/Sedan/Wagon 1997 até 2003
Pointer 1994 até 1996



ELECTRICA - S/MOTOR

Máquina levanta cristal - 2 puertas - Mabuchi (8 dientes)

R-4180D SM
O&M: 5Z3837502A SM
R-4180E SM
O&M: 5Z3837501A SM



Fox 2003 em diante 2P



ELECTRICA - S/MOTOR

Máquina levanta cristal - 2 puertas - Bosch (10 dientes)

R-4198D SM
O&M: 5Z3837502A SM
R-4198E SM
O&M: 5Z3837501A SM



Fox 2003 em diante 2P

ELECTRICA - S/MOTOR

Máquina levanta cristal - 4 puertas - delantero - Mabuchi (8 dientes)

R-4181D SM
O&M: 5Z4837402A SM
R-4181E SM
O&M: 5Z4837401A SM



CrossFox 2005 em diante
Fox 2003 em diante 4P
SpaceFox 2006 em diante

ELECTRICA - S/MOTOR

Máquina levanta cristal - 4 puertas - delantero - Bosch (10 dientes)

R-4199D SM
O&M: 5Z4837402A SM
R-4199E SM
O&M: 5Z4837401A SM



CrossFox 2005 em diante
Fox 2003 em diante 4P
SpaceFox 2006 em diante

ELECTRICA - S/MOTOR

Máquina levanta cristal - 4 puertas - trasero - Mabuchi (8 dientes)

R-4182D SM
O&M: 5Z4839402 SM
R-4182E SM
O&M: 5Z4839401 SM



CrossFox 2005 em diante
Fox 2003 em diante
SpaceFox 2006 em diante

ELECTRICA - S/MOTOR

Máquina levanta cristal - 4 puertas - trasero - Bosch (10 dientes)

R-4183D SM
O&M: 5Z4839402 SM
R-4183E SM
O&M: 5Z4839401 SM



CrossFox 2005 em diante
Fox 2003 em diante
SpaceFox 2006 em diante

ELECTRICA - S/MOTOR

Máquina levanta cristal - 4 puertas - trasero - Mabuchi (8 dientes)

R-4118D SM
O&M: 1SB837462C SM
R-4118E SM
O&M: 1SB837461C SM



Up! 2014 em diante

Reparación máquina levanta cristal eléctricos - 4 puertas - delantero - sin motor - Mabuchi (8 dientes)

R-4117D SM
O&M: 6RU959801 SM
R-4117E SM
O&M: 6RU959802 SM



Up! 2014 em diante

Reparación máquina levanta cristal eléctricos - 2 puertas - delantero - sin motor - Mabuchi (8 dientes)

R-4178D SM
O&M: IJ3837462 SM
R-4178E SM
O&M: IJ3837461 SM



Amarok 2010 em diante
Golf 1999 até 2014
Polo 2002 até 2014

ELECTRICA - S/MOTOR

Máquina levanta cristal - 4 puertas - trasero - original (32 estrías)

R-4415D SM
O&M: 6EA839462
R-4415E SM
O&M: 6EA839461



Nivus 2018 em diante
Polo 2018 em diante
Virtus 2018 em diante

Reparación máquina levanta cristal eléctricos - 4 puertas - delantero - con motor - Mabuchi (8 dientes)

R-4117D
O&M: 6RU959801
R-4117E
O&M: 6RU959802



Up! 2014 em diante

Reparación máquina levanta cristal eléctricos - 2 puertas - delantero - con motor - Mabuchi (8 dientes)

R-4178D
O&M: IJ3837462
R-4178E
O&M: IJ3837461



Amarok 2010 em diante
Golf 1999 até 2014
Polo 2002 até 2014

MANUAL

Máquina levanta cristal - 2 puertas - pin alto

R-5215D
O&M: 86ABB23200AA
R-5215E
O&M: 86ABB23201AA



Apollo 1990 até 1992
Escort 1987 até 1992
Escort Hobby 1993 até 1996
Verona 1990 até 1993



MANUAL

Máquina levanta cristal - de tornillo - pin bajo

R-7707D
O&M: 141837502A
R-7707E
O&M: 141837501A



Karmann-Ghia 1962 até 1972

MANUAL

Máquina levanta cristal - de pinza - pin alto

R-7708D
O&M: 141837502A
R-7708E
O&M: 141837501A



Karmann-Ghia 1962 até 1972

MANUAL

Máquina levanta cristal - 2 puertas/4 puertas - delantero

R-4184D
O&M: ZBC837502D
R-4184E
O&M: ZBC837501E



Royale 1992 até 1996
Santana 1984 até 1998
Santana Quantum 1984 até 1998
Versailles 1991 até 1996



MANUAL

Máquina levanta cristal - 4 puertas - trasero

R-4185D
O&M: ZBC839502D
R-4185E
O&M: ZBD839501E



Royale 1992 até 1996
Santana 1984 até 1998
Santana Quantum 1984 até 1998
Versailles 1991 até 1996



MANUAL

Máquina levanta cristal - 2 puertas

R-4172D
O&M: 547837502B
R-4172E
O&M: 547837501B



Escort 1993 até 1996
Logus 1993 até 1997



MANUAL

Máquina levanta cristal - 4 puertas - delantero

R-5216D
O&M: 95ABA23201AA
R-5216E
O&M: 95ABA23202AA



Escort Hatch/Sedan/Wagon 1997 até 2003
Pointer 1994 até 1996



MANUAL

Máquina levanta cristal - 4 puertas - trasero

R-5250D
O&M: 95ABA27000AA
R-5250E
O&M: 95ABA27001AA



Escort hatch 1997 até 2003
Escort sedan 1997 até 1998
Escort SW 1997 até 2003
Pointer 1994 até 1996
Verona 1993 até 1996



ELECTRICA - S/MOTOR - motor inverso

Máquina levanta cristal - 2 puertas/4 puertas - delantero - Mabuchi (8 dientes)

R-4190D SM
O&M: ZBC837502A SM
R-4190E SM
O&M: ZBC837501A SM



Royale 1992 até 1996
Santana 1984 até 1998
Santana Quantum 1984 até 1998
Versailles 1991 até 1996



ELECTRICA - S/MOTOR

Máquina levanta cristal - 2 puertas - Mabuchi (8 dientes)

R-4173D SM
O&M: 547837502D SM
R-4173E SM
O&M: 547837501D SM



Escort 1993 até 1996
Logus 1993 até 1997



ELECTRICA - S/MOTOR

Máquina levanta cristal - 4 puertas - delantero - Mabuchi (8 dientes)

R-5230D SM
O&M: 97AGA23200AA SM
R-5230E SM
O&M: 97AGA23201AA SM



Escort Hatch/Sedan/Wagon 1997 até 2003
Pointer 1994 até 1996
Verona 1994 até 1996



ELECTRICA - S/MOTOR

Máquina levanta cristal - 4 puertas - trasero - Mabuchi (8 dientes)

R-5232D SM
O&M: 97AGA27000BA SM
R-5232E SM
O&M: 97AGA27001BA SM



Escort Hatch/Sedan/Wagon 1997 até 2003
Pointer 1994 até 1996



MANUAL

Máquina levanta cristal - 2 puertas/4 puertas - delantero

R-5102D
O&M: BD5M5423201A
R-5102E
O&M: BD5M5423200A



Belina 1972 até 1977
Corcel 1972 até 1978

MANUAL

Máquina levanta cristal - 2 puertas

R-5140D
O&M: BD8M6223200A
R-5140E
O&M: BD8M6223201A



Belina II 1978 até 1991
Corcel II 1979 até 1981

MANUAL

Máquina levanta cristal - 2 puertas

R-5142D
O&M: 80NU6223200A
R-5142E
O&M: 80NU6223201A



Belina II 1982 até 1991
Corcel II 1982 até 1986
Del Rey 1981 até 1991



MANUAL

Máquina levanta cristal - 2 puertas - 4 puertas

R-5143D
O&M: 81EU5423200A
R-5143E
O&M: 81EU5423201A



Del Rey 1981 até 1991
Pampa 1982 até 1997

MANUAL

Máquina levanta cristal - 2 puertas - pin bajo

R-5210D
O&M: 81ABB23200AF
R-5210E
O&M: 81ABB23201AF



Escort 1983 até 1986

MANUAL

Máquina levanta cristal - 4 puertas - delantero - pin bajo

R-5210D 4D
O&M: 81ABA23200AE
R-5210E 4D
O&M: 81ABA23201AE



Escort 1983 até 1986

MANUAL

Máquina levanta cristal - 2 puertas - pin alto

R-5215D
O&M: 86ABB23200AA
R-5215E
O&M: 86ABB23201AA



Apollo 1990 até 1992
Escort 1987 até 1992
Escort Hobby 1993 até 1996
Verona 1990 até 1993

MANUAL

Máquina levanta cristal - 4 puertas - delantero - pin alto

R-5215D 4D
O&M: 86ABA23200AE
R-5215E 4D
O&M: 86ABA23201AE



Escort Guarájá 1991 até 1993

MANUAL

Máquina levanta cristal - 2 puertas

R-5220D
O&M: 96FGB23200AC
R-5220E
O&M: 96FGB23201AC



Courier 1997 até 2013
Fiesta 1996 até 2003

MANUAL

Máquina levanta cristal - 4 puertas - delantero

R-5221D
O&M: 96FGA23200AC
R-5221E
O&M: 96FGA23201AC



Fiesta 1996 até 2003 Street

MANUAL

Máquina levanta cristal - 4 puertas - delantero

R-5138D
O&M: 2S65A23230AG
R-5138E
O&M: 2S65A23231AG



Fiesta 2002 até 2014 Amazon

MANUAL

Máquina levanta cristal - 4 puertas - trasero

R-5139D
O&M: 2S65A27000AF
R-5139E
O&M: 2S65A27001AF



Fiesta 2002 até 2014 Amazon

MANUAL

Máquina levanta cristal - 2 puertas

R-5144D
O&M: 97KGB23200AF
R-5144E
O&M: 97KGB23201AF

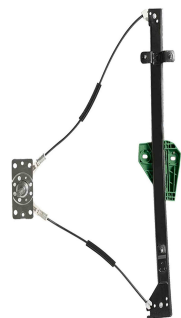

Ka 1997 até 2007

MANUAL

Máquina levanta cristal - 2 puertas

R-5150D
O&M: 98KUB23200CA
R-5150E
O&M: 98KUB23201CA



Ka 2008 até 2014

ELECTRICA - S/MOTOR

Máquina levanta cristal - 2 puertas - Mabuchi (8 dientes)

R-5245D SM
O&M: 82EU6223200A SM
R-5245E SM
O&M: 82EU6223201A SM



Belina II 1982 até 1991
Corcel II 1981 em diante
Del Rey 1981 até 1991

ELECTRICA - S/MOTOR

Máquina levanta cristal - 4 puertas - delantero - Mabuchi (8 dientes)

R-5246D SM
O&M: 82EU5423200A SM
R-5246E SM
O&M: 82EU5423201A SM



Del Rey 1981 até 1991
Pampa 1982 até 1997

ELECTRICA - S/MOTOR

Máquina levanta cristal - 4 puertas - delantero - Mabuchi (8 dientes)

R-5224D SM
O&M: 2N15M23200BE SM
R-5224E SM
O&M: 2N15M23201BE SM



EcoSport 2003 até 2012

ELECTRICA - S/MOTOR

Máquina levanta cristal - 4 puertas - trasero - Mabuchi (8 dientes)

R-5225D SM
O&M: 2N15N27000BD SM
R-5225E SM
O&M: 2N15N27001BD SM



EcoSport 2003 até 2012

ELECTRICA - S/MOTOR

Máquina levanta cristal - 4 puertas - delantero - original (10 dientes)

R-5258D SM
O&M: 2N15N23200BE
R-5258E SM
O&M: 2N15N23201BE



EcoSport 2003 até 2012

ELECTRICA - S/MOTOR

Máquina levanta cristal - 4 puertas - delantero - original (34 estrías)

R-5254D SM
O&M: CN15A23201EB
R-5254E SM
O&M: CN15A23200EB

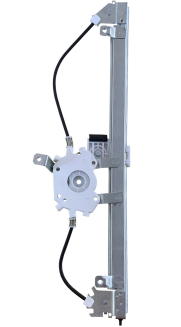

EcoSport 2013 em diante

ELECTRICA - S/MOTOR

Máquina levanta cristal - 2 puertas - Mabuchi (8 dientes)

R-5219D SM
O&M: 98FG/B23200/BA SM
R-5219E SM
O&M: 98FG/B23201/BA SM



Courier 1997 até 2013
Fiesta 1996 até 2003

ELECTRICA - S/MOTOR

Máquina levanta cristal - 4 puertas - delantero - Mabuchi (8 dientes)

R-5218D SM
O&M: 96/FGA23200BB SM
R-5218E SM
O&M: 96/FGA23201BB SM



Fiesta 1996 até 2003 Street

Reparación máquina levanta cristal eléctricos - 4 puertas - trasero - sin motor - Mabuchi (8 dientes)

R-5217D SM
R-5217E SM



Fiesta 2013 em diante excepto Rocan hasta 2014

ELECTRICA - S/MOTOR

Máquina levanta cristal - 4 puertas - delantero - Mabuchi (8 dientes)

R-5231D SM
O&M: 2S65A23200BF SM
R-5231E SM
O&M: 2S65A23201BF SM



Fiesta 2002 até 2014 Amazon

ELECTRICA - S/MOTOR

Máquina levanta cristal - 4 puertas - trasero - Mabuchi (8 dientes)

R-5234D SM
O&M: 2S65A27200BF SM
R-5234E SM
O&M: 2S65A27001BF SM



Fiesta 2002 até 2014 Amazon

ELECTRICA - S/MOTOR - motor inverso

Máquina levanta cristal - 2 puertas - Mabuchi (8 dientes)

R-5145D SM
O&M: 97KG/B23200/BE SM
R-5145E SM
O&M: 97KG/B23201/BE SM



Ka 1997 até 2007

ELECTRICA - S/MOTOR

Máquina levanta cristal - 2 puertas - Mabuchi (8 dientes)

R-5151D SM
O&M: 96KGB23200BE SM
R-5151E SM
O&M: 96KGB23201BE SM



Ka 2008 até 2014

ELECTRICA - S/MOTOR

Máquina levanta cristal - 4 puertas - delantero - Mabuchi (8 dientes)

R-5155D SM
O&M: E3B5A23200DE SM
R-5155E SM
O&M: E3B5A23201DE SM



Ka 2014 em diante
Ka+ (sedan) 2014 em diante

ELECTRICA - S/MOTOR

Máquina levanta cristal - 4 puertas - trasero - Mabuchi (8 dientes)

R-5156D SM
O&M: E3B5A27000BE SM
R-5156E SM
O&M: E3B5A27001BE SM

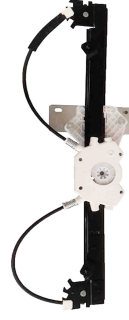

Ka 2014 em diante
Ka+ (sedan) 2014 em diante

Reparación máquina levanta cristal eléctricos - 4 puertas - trasero - con motor - Mabuchi (8 dientes)

R-5217D
R-5217E



Fiesta 2013 em diante excepto Rocan hasta 2014

ELECTRICA - S/MOTOR

Máquina levanta cristal - 4 puertas - delantero - original (8 dientes)

R-7402D SM
O&M: 9222FH SM
R-7402E SM
O&M: 9221FH SM



C3 2008 até 2012

ELECTRICA - S/MOTOR

Máquina levanta cristal - 4 puertas - trasero - original (8 dientes)

R-7403D SM
O&M: 9224G1 SM
R-7403E SM
O&M: 9223G1 SM



C3 2008 até 2012

ELECTRICA - S/MOTOR

Máquina levanta cristal - 4 puertas - trasero - Mabuchi (8 dientes)

R-7408D SM
O&M: 9837248380 SM
R-7408E SM
O&M: 9838919880 SM



C3 2023 em diante

ELECTRICA - S/MOTOR

Máquina levanta cristal - Mabuchi (8 dientes)

R-7718D SM
O&M: 9221G3
R-7718E SM
O&M: 9221G3



Berlingo 1998 até 2006
Partner 1999 em diante

MANUAL

Máquina levanta cristal - 2 puertas



R-7497D
O&M: 7700303552
R-7497E
O&M: 7700303542

Kangoo 1999 até 2017

MANUAL

Máquina levanta cristal - 2 puertas



R-7494D
O&M: 7700842244
R-7494E
O&M: 7700842245

Clio 1999 até 2016



MANUAL

Máquina levanta cristal - 4 puertas - delantero



R-7495D
O&M: 7700842238
R-7495E
O&M: 7700842239

Clio 1999 até 2016

MANUAL

Máquina levanta cristal - 4 puertas - trasero

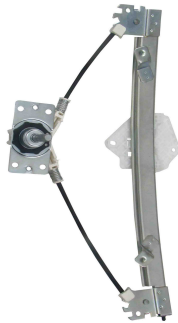

R-7496D
O&M: 7700434304
R-7496E
O&M: 7700434303

Clio 1999 até 2016
Symbol 2009 até 2013



MANUAL

Máquina levanta cristal - 2 puertas



R-7514D
O&M: 8200603800
R-7514E
O&M: 8200603829

Sandero 2007 até 2014



ELECTRICA - S/MOTOR - motor inverso

Máquina levanta cristal - 2 puertas - Mabuchi (8 dientes)



R-7500D SM
O&M: 7700842246 SM
R-7500E SM
O&M: 7700842247 SM

Clio 1999 até 2016



ELECTRICA - S/MOTOR

Máquina levanta cristal - 4 puertas - delantero - Mabuchi (8 dientes)



R-7501D SM
O&M: 7700842240 SM
R-7501E SM
O&M: 7700842241 SM

Clio 1999 até 2016
Symbol 2009 até 2013



ELECTRICA - S/MOTOR - motor inverso

Máquina levanta cristal - 4 puertas - delantero - Mabuchi (8 dientes)



R-7502D SM
O&M: 8200619597 SM
R-7502E SM
O&M: 8200619599 SM

Logan 2007 até 2013



ELECTRICA - S/MOTOR - motor inverso

Máquina levanta cristal - 4 puertas - trasero - Mabuchi (8 dientes)



R-7504D SM
O&M: 8200619588 SM
R-7504E SM
O&M: 8200619589 SM

Logan 2007 até 2013



ELECTRICA - S/MOTOR - motor inverso

Máquina levanta cristal - 4 puertas - delantero - Mabuchi (8 dientes)



R-7508D SM
O&M: 807211440R SM
R-7508E SM
O&M: 807209299R SM

Logan nov/2013 em diante
Sandero nov/2013 em diante

ELECTRICA - S/MOTOR - motor inverso

Máquina levanta cristal - 4 puertas - trasero - Mabuchi (8 dientes)



R-7509D SM
O&M: 827206057R SM
R-7509E SM
O&M: 827211331R SM

Logan nov/2013 em diante
Sandero nov/2013 em diante



ELECTRICA - S/MOTOR - motor inverso

Máquina levanta cristal - 4 puertas - delantero - Mabuchi (8 dientes)



R-7503D SM
O&M: 8200603862 SM
R-7503E SM
O&M: 8200603858 SM

Duster 2011 em diante
Duster Oroch 2015 em diante
Sandero 2007 até 2014



ELECTRICA - S/MOTOR - motor inverso

Máquina levanta cristal - 4 puertas - trasero - Mabuchi (8 dientes)

R-7505D SM
O&M: 8200603810 SM
R-7505E SM
O&M: 8200603795 SM



Duster 2011 em diante
Duster Oroch 2015 em diante
Sandero 2007 até 2014



ELECTRICA - S/MOTOR - motor inverso

Máquina levanta cristal - 4 puertas - delantero - Mabuchi (8 dientes)

R-7510D SM
O&M: 807207299 SM
R-7510E SM
O&M: 807213077 SM



Kwid 2017 em diante



ELECTRICA - S/MOTOR

Máquina levanta cristal - 4 puertas - trasero - Mabuchi (8 dientes)

R-7511D SM
O&M: 827202595 SM
R-7511E SM
O&M: 827219407 SM



Kwid 2017 em diante



MANUAL

Máquina levanta cristal - 2 puertas/4 puertas - delantero

R-7719D
O&M: 9222EX
R-7719E
O&M: 9221EX



206 2008 até jan/2009
207 Passion/SW 2009 até jan/2014 4P
Hoggar nov/2010 até 2014



ELECTRICA - S/MOTOR

Máquina levanta cristal - Mabuchi (8 dientes)

R-7718D SM
O&M: 9221G3
R-7718E SM
O&M: 9221G3



Berlingo 1998 até 2006
Partner 1999 em diante



ELECTRICA - S/MOTOR

Máquina levanta cristal - 2 puertas - Mabuchi (8 dientes)

R-7713D SM
O&M: 9222F7 SM
R-7713E SM
O&M: 9221F9 SM

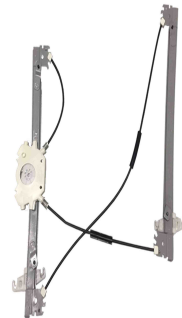

206 2008 até jan/2009 2P
207 2009 até 2014 2P



ELECTRICA - S/MOTOR

Máquina levanta cristal - 2 puertas - original (10 dientes)

R-7716D SM
O&M: 9222F7 SM
R-7716E SM
O&M: 9221F9 SM

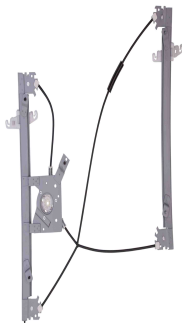

206 2008 até jan/2009 2P
207 2009 até 2014 2P



ELECTRICA - S/MOTOR

Máquina levanta cristal - 2 puertas/4 puertas - delantero - Mabuchi (8 dientes)

R-7711D SM
O&M: 9222EY SM
R-7711E SM
O&M: 9221EY SM

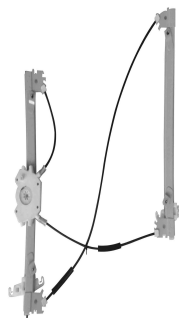

206 2008 até jan/2009
207 Passion/SW 2009 até jan/2014 4P
Hoggar nov/2010 até 2014



ELECTRICA - S/MOTOR

Máquina levanta cristal - 2 puertas/4 puertas - delantero - original (10 dientes)

R-7714D SM
O&M: 9222EY SM
R-7714E SM
O&M: 9221EY SM

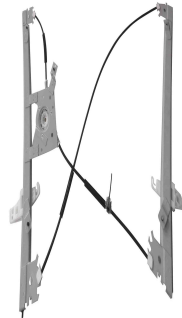

206 2008 até jan/2009 4P
207 Passion/SW 2009 até jan/2014 4P
Hoggar nov/2010 até 2014



ELECTRICA - S/MOTOR

Máquina levanta cristal - 4 puertas - trasero - Mabuchi (8 dientes)

R-7712D SM
O&M: 9224F2 SM
R-7712E SM
O&M: 9223E8 SM



206 2008 até jan/2009 4P
207 Passion/SW 2009 até jan/2014 4P



ELECTRICA - S/MOTOR

Máquina levanta cristal - 4 puertas - trasero - Mabuchi (8 dientes)

R-7724D SM
O&M: 9829045980 SM
R-7724E SM
O&M: 9829045981 SM



208 2021 em diante



Reparación máquina levanta cristal eléctricos - 2 puertas/4 puertas - delantero - sin motor - Mabuchi (8 dientes)

R-7710D SM
R-7710E SM



206 1998 até 2007

Reparación máquina levanta cristal eléctricos - 2 puertas/4 puertas - delantero - con motor - Mabuchi (8 dientes)



R-7710D
R-7710E

206 1998 até 2007

ELECTRICA - S/MOTOR

Máquina levanta cristal - 4 puertas - delantero - Mabuchi (8 dientes)

R-7522D SM
O&M: 824041S010 SM
R-7522E SM
O&M: 824031S010 SM



HB20 2012 em diante

ELECTRICA - S/MOTOR

Máquina levanta cristal - 4 puertas - trasero - Mabuchi (8 dientes)

R-7523D SM
O&M: 834041S010 SM
R-7523E SM
O&M: 834031S010 SM



HB20 2012 até 2019

ELECTRICA - S/MOTOR - motor inverso

Máquina levanta cristal - 4 puertas - trasero - Mabuchi (8 dientes)

R-7526D SM
O&M: 83404R1010 SM
R-7526E SM
O&M: 83403R1010 SM

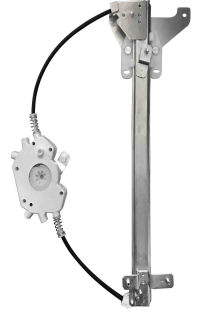

HB20 2020 em diante

ELECTRICA - S/MOTOR

Máquina levanta
cristal - 4 puertas -
trasero -
original (eje estrella 8 c

R-7573D SM
O&M: 72710SNAA01 SM
R-7573E SM
O&M: 72750SNAA01 SM



Civic jun/2006 até 2011

ELECTRICA - S/MOTOR

Máquina levanta cristal - 4 puertas - delantero - Mabuchi (8 dientes)

R-7517D SM
O&M: 698010D150 SM
R-7517E SM
O&M: 698020D160 SM



Etios 2012 em diante

ELECTRICA - S/MOTOR

Máquina levanta cristal - 4 puertas - trasero - Mabuchi (8 dientes)

R-7518D SM
O&M: 698030D130 SM
R-7518E SM
O&M: 698040D130 SM



Etios 2012 em diante

ELECTRICA - S/MOTOR

Máquina levanta cristal - 4 puertas - delantero - original (8 dientes)

R-7546D SM
O&M: 130822030
R-7546E SM
O&M: 130822031



Corolla 2003 até 2008
Fielder 2004 até 2008



ELECTRICA - S/MOTOR

Máquina levanta cristal - 4 puertas - delantero - original (8 dientes)

R-7542D SM
O&M: 6980102250 SM
R-7542E SM
O&M: 6980202260 SM

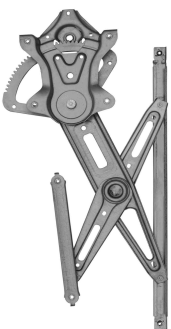

Corolla 2009 até 2014

ELECTRICA - S/MOTOR

Máquina levanta cristal - 4 puertas - trasero - original (8 dientes)

R-7543D SM
O&M: 6980302210 SM
R-7543E SM
O&M: 6980402210 SM

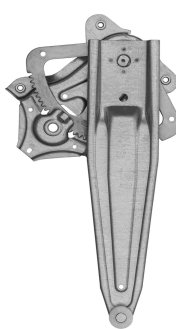

Corolla 2009 até 2014

ELECTRICA - S/MOTOR

Máquina levanta cristal - 4 puertas - delantero - Mabuchi (8 dientes)

R-7515D SM
O&M: 807201HLOA SM
R-7515E SM
O&M: 807211HLOA SM



March 2011 em diante
Versa 2011 em diante

ELECTRICA - S/MOTOR - motor inverso

Máquina levanta cristal - 4 puertas - trasero - Mabuchi (8 dientes)

R-7516D SM
O&M: 827201HLOA SM
R-7516E SM
O&M: 827211HLOA SM



March 2011 em diante
Versa 2011 em diante

MANUAL

Máquina levanta cristal - 2 puertas

R-1423D
O&M: 1320337080
R-1423E
O&M: 1320338080



Boxer 2000 até 2016
Ducato 1999 até 2016
Jumper 2007 até 2016

ELECTRICA - S/MOTOR

Máquina levanta cristal - 2 puertas - Mabuchi (8 dientes)

R-1432D SM
O&M: 1341395080 SM
R-1432E SM
O&M: 1341396080 SM



Boxer 2000 em diante
Ducato 1999 em diante
Jumper 2007 em diante

MANUAL

Máquina levanta cristal - 2 puertas

R-1422D
O&M: 93941270
R-1422E
O&M: 93941271



Daily 1997 até 2007

MANUAL

Máquina levanta cristal - 2 puertas

R-1419D
O&M: 504205269
R-1419E
O&M: 504205271



Daily 2008 até 2013
Master 2008 até 2013

ELECTRICA - S/MOTOR

Máquina levanta cristal - 2 puertas - Mabuchi (8 dientes)

R-1449D SM
O&M: 4856368 SM
R-1449E SM
O&M: 4856369 SM



Daily 1997 até 2007

ELECTRICA - S/MOTOR

Máquina levanta cristal - 2 puertas - Mabuchi (8 dientes)

R-1444D SM
O&M: 504173869 SM
R-1444E SM
O&M: 504173868 SM



Daily 2008 em diante
Master 2008 até 2013

ELECTRICA - S/MOTOR

Máquina levanta cristal - 2 puertas - original (4 dientes)

R-1450D SM
O&M: 504173869 SM
R-1450E SM
O&M: 504173868 SM



Daily 2008 em diante
Master 2008 até 2013

MANUAL

Máquina levanta cristal - 2 puertas

R-2304D
O&M: 9017201546
R-2304E
O&M: 9017201446



Sprinter 1997 até 2012

ELECTRICA - S/MOTOR

Máquina levanta cristal - 2 puertas - original (32 estrías)

R-2127D SM
O&M: A9067200046 SM
R-2127E SM
O&M: A9067200146 SM

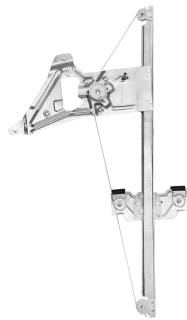

Sprinter 2012 em diante

ELECTRICA - S/MOTOR

Máquina levanta
cristal - 2 puertas -
original (8 dientes)



R-5152D SM

O&M: 6C11V23200AD SM

R-5152E SM

O&M: 6C11V23201AD SM

Transit 2008 até 2013

ELECTRICA - S/MOTOR

Máquina levanta cristal -
Mabuchi (8 dientes)

R-7718D SM
O&M: 9221G3
R-7718E SM
O&M: 9221G3



Berlingo 1998 até 2006
Partner 1999 em diante

MANUAL

Máquina levanta cristal - 2 puertas

R-1423D
O&M: 1320337080
R-1423E
O&M: 1320338080



Boxer 2000 até 2016
Ducato 1999 até 2016
Jumper 2007 até 2016

ELECTRICA - S/MOTOR

Máquina levanta cristal - 2 puertas -
Mabuchi (8 dientes)

R-1432D SM
O&M: 1341395080 SM
R-1432E SM
O&M: 1341396080 SM



Boxer 2000 em diante
Ducato 1999 em diante
Jumper 2007 em diante

MANUAL

Máquina levanta cristal - 2 puertas



R-7497D
O&M: 7700303552
R-7497E
O&M: 7700303542

Kangoo 1999 até 2017

MANUAL

Máquina levanta cristal - 2 puertas



R-1419D
O&M: 504205269
R-1419E
O&M: 504205271

Daily 2008 até 2013
Master 2008 até 2013



MANUAL

Máquina levanta cristal



R-7512D
O&M: 807200009R
R-7512E
O&M: 807210009R

Master 2014 em diante



ELECTRICA - S/MOTOR

Máquina levanta cristal - 2 puertas - Mabuchi (8 dientes)



R-1444D SM
O&M: 504173869 SM
R-1444E SM
O&M: 504173868 SM

Daily 2008 em diante
Master 2008 até 2013



ELECTRICA - S/MOTOR

Máquina levanta cristal - 2 puertas - original (4 dientes)



R-1450D SM
O&M: 504173869 SM
R-1450E SM
O&M: 504173868 SM

Daily 2008 em diante
Master 2008 até 2013



MANUAL

Máquina levanta cristal - 2 puertas



R-7498D
O&M: 7702088121D
R-7498E
O&M: 7702088122E

Trafic 1991 até 2001
Trafic 1995 até 2001

ELECTRICA - S/MOTOR

Máquina levanta cristal - 2 puertas - Mabuchi (8 dientes)



R-7506D SM
O&M: 8200467967 SM
R-7506E SM
O&M: 8200467971 SM

Master 2014 em diante



ELECTRICA - S/MOTOR

Máquina levanta cristal - 2 puertas - original (32 estrías)



R-7513D SM
O&M: 807200008R
R-7513E SM
O&M: 807210008R

Master 2014 em diante



ELECTRICA - S/MOTOR

Máquina levanta cristal - Mabuchi (8 dientes)

R-7718D SM
O&M: 9221G3
R-7718E SM
O&M: 9221G3



Berlingo 1998 até 2006
Partner 1999 em diante

MANUAL

Máquina levanta cristal - 2 puertas

R-1423D
O&M: 1320337080
R-1423E
O&M: 1320338080



Boxer 2000 até 2016
Ducato 1999 até 2016
Jumper 2007 até 2016

ELECTRICA - S/MOTOR

Máquina levanta cristal - 2 puertas - Mabuchi (8 dientes)

R-1432D SM
O&M: 1341395080 SM
R-1432E SM
O&M: 1341396080 SM



Boxer 2000 em diante
Ducato 1999 em diante
Jumper 2007 em diante

MANUAL

Máquina levanta cristal - 2 puertas

R-7530D
O&M: OS08458560C
R-7530E
O&M: OS08459560C



Besta 2.2/2.8 1993 até 1998

MANUAL

Máquina levanta cristal - 2 puertas

R-7531D
O&M: OK72C58560A
R-7531E
O&M: OK72C59560A



Besta GS 1998 até 2006

MANUAL

Máquina levanta cristal - 2 puertas/4 puertas

R-7533D
O&M: 824014E000
R-7533E
O&M: 824024E000



Bongo 2006 em diante

ELECTRICA - S/MOTOR - motor inverso

Máquina levanta cristal - 2 puertas/4 puertas - delantero - Mabuchi (8 dientes)

R-7532D SM
O&M: 824044E010
R-7532E SM
O&M: 824034E010



Bongo 2006 em diante

MANUAL

Máquina levanta cristal - 2 puertas

R-7524D
O&M: 824014F000
R-7524E
O&M: 824014F001



HR 2005 em diante

ELECTRICA - S/MOTOR

Máquina levanta cristal - 2 puertas - Mabuchi (8 dientes)

R-7521D SM
O&M: 824024F000 SM
R-7521E SM
O&M: 824014F000 SM



HR 2005 em diante

MANUAL

Máquina levanta cristal - 2 puertas

R-7498D
O&M: 7702088121D
R-7498E
O&M: 7702088122E



Trafic 1991 até 2001
Trafic 1995 até 2001

Cerradura de puerta - central - de la porta del medio - con traba

F-4211
O&M: 2118416051



Kombi Clipper 1976 até 1996

Cerradura del maletero - tapa

F-4202T
O&M: 2318292111

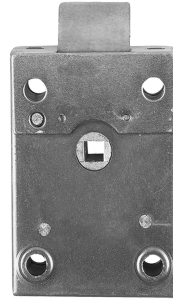

Kombi 1957 até 1996

Cerradura del maletero - tapa

F-4206T
O&M: 211829211H



Kombi 1997 até 2014

Cerradura de puerta - central - de la porta del medio - con enganche (gancho)

F-4213
O&M: 211843604J



Kombi 1997 até 2014

Cerradura de puerta - central - de la porta del medio - con traba - con manija

F-4205
O&M: 211843654



Kombi 1997 até 2014

Cerradura de puerta - delantero

F-4498D
O&M: 2318370161
F-4498E
O&M: 2318370151



Kombi Clipper 1976 até 1996
Worker / Titan / Tractor 1980 em diante

MANUAL

Máquina levanta cristal - 2 puertas - pin bajo - fijado con remache

R-4171D
O&M: 2118375021
R-4171E
O&M: 2118375011



Kombi 1976 até 2007

MANUAL

Máquina levanta cristal - pin bajo - fijado con tornillos M6x10mm

R-4405D
O&M: 2118375021
R-4405E
O&M: 2118375011



Kombi 1976 até 2007

MANUAL

Máquina levanta cristal - 2 puertas - pin alto

R-4099D
O&M: 7X0837502
R-4099E
O&M: 7X0837501



Kombi 2008 até 2014

ELECTRICA - S/MOTOR

Máquina levanta cristal - 2 puertas - Mabuchi (8 dientes)

R-4176D SM
O&M: 2118375021 SM
R-4176E SM
O&M: 2118375011 SM



Kombi 1976 até 2014

Bisagra tapa delantera - con resorte

D-3383D
O&M: 7362032
D-3383E
O&M: 7362031



A-10 até 1984
C-10 até 1984
D-10 até 1984

Bisagra tapa delantera - con resorte

D-3384D
O&M: 94630704
D-3384E
O&M: 94630703



C-20 1985 em diante
D-20 1985 em diante
D-40 1985 em diante

Bisagra tapa delantera - soporte

S-3385



A-10 até 1984
C-10 até 1984
D-10 até 1984

MANUAL

Máquina levanta cristal - 2 puertas - delantero

R-3114D
O&M: 7320092
R-3114E
O&M: 7320091



C-10 1972 até 1985
D-10 1979 até 1985
D-60 1965 até 1985
Veraneio 1971 até 1985



MANUAL

Máquina levanta cristal - 2 puertas

R-3116D
O&M: 94637552
R-3116E
O&M: 94637551



A-20 1985 até 1990
A-40 1985 até 1990
C-20 1985 até 1990
D-20 1985 até 1990
D-40 1985 até 1990



MANUAL

Máquina levanta cristal - 2 puertas/4 puertas - delantero

R-3346D
O&M: 52255122
R-3346E
O&M: 52255121

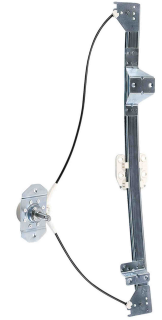

A-20 1991 até 1996
A-40 1991 até 1996
Bonanza 1991 até 1994
C-20 1991 até 1996
D-12000 1991 até 1996
D-20 1991 até 1996
D-40 1991 até 1996
Veraneio 1991 até 1994



MANUAL

Máquina levanta cristal - 4 puertas - trasero

R-3347D
O&M: 52255126
R-3347E
O&M: 52255125



A-20 1991 até 1996
A-40 1991 até 1996
Bonanza 1991 até 1994
C-20 1991 até 1996
D-12000 1991 até 1996
D-20 1991 até 1996
D-40 1991 até 1996
Veraneio 1991 até 1994



MANUAL

Máquina levanta cristal - 2 puertas/4 puertas - delantero

R-3345D
O&M: 15705142
R-3345E
O&M: 15705141



Blazer 1995 até 2011
S10 1995 até 2011



ELECTRICA - S/MOTOR - motor inverso

Máquina levanta cristal - 4 puertas - delantero - Mabuchi (8 dientes)

R-3332D SM
O&M: 52255124 SM
R-3332E SM
O&M: 52255123 SM



A-20 1991 até 1996
Bonanza 1991 até 1994
C-20 1991 até 1996
D-20 1991 até 1996
Veraneio 1991 até 1994



ELECTRICA - S/MOTOR

Máquina levanta cristal - 4 puertas - trasero - Mabuchi (8 dientes)

R-3333D SM
O&M: 52255128 SM
R-3333E SM
O&M: 52255127 SM

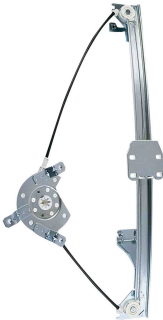

A-20 1991 até 1996
Bonanza 1991 até 1994
C-20 1991 até 1996
D-20 1991 até 1996
Veraneio 1991 até 1994



ELECTRICA - S/MOTOR - motor inverso

Máquina levanta cristal - 2 puertas/4 puertas - delantero - Mabuchi (8 dientes)

R-3344D SM
O&M: 15705144 SM
R-3344E SM
O&M: 15705143 SM



Blazer 1995 até 2011
S10 1995 até 2011



ELECTRICA - S/MOTOR

Máquina levanta cristal - 2 puertas/4 puertas - delantero - Mabuchi (8 dientes)

R-3357D SM
O&M: 947736650 SM
R-3357E SM
O&M: 947736649 SM



S10 2012 em diante

ELECTRICA - S/MOTOR - motor inverso

Máquina levanta cristal - 4 puertas - trasero - Mabuchi (8 dientes)

R-3358D SM
O&M: 5483149 SM
R-3358E SM
O&M: 5483148 SM



S10 2012 em diante

ELECTRICA - S/MOTOR - motor inverso

Máquina levanta cristal - 4 puertas - trasero - Mabuchi (8 dientes) - el cristal baja hasta el final del curso

R-3363D SM
O&M: 5483149 SM
R-3363E SM
O&M: 5483148 SM



S10 2012 em diante

ELECTRICA - S/MOTOR

Máquina levanta cristal - delantero - original

R-4143D SM
O&M: 2H0837402H
R-4143E SM
O&M: 2H0837401L



Amarok 2010 em diante

Reparación máquina levanta cristal eléctricos - 2 puertas - delantero - sin motor - Mabuchi (8 dientes)

R-4178D SM
O&M: IJ3837462 SM
R-4178E SM
O&M: IJ3837461 SM



Amarok 2010 em diante
Golf 1999 até 2014
Polo 2002 até 2014

Reparación máquina levanta cristal eléctricos - 2 puertas - delantero - con motor - Mabuchi (8 dientes)

R-4178D
O&M: IJ3837462
R-4178E
O&M: IJ3837461



Amarok 2010 em diante
Golf 1999 até 2014
Polo 2002 até 2014

Bisagra tapa delantera - con resorte

D-5238D
O&M: 90TU16800A
D-5238E
O&M: 90TU16801A



F-1000 até 1992
F-4000 até 1992

Bisagra tapa delantera - con resorte

D-5239D
O&M: TNK823335
D-5239E
O&M: EITQ16796A



F-1000 1992 até 1998
F-4000 1992 até 1998

Cierre del capot - inferior

F-5242I
O&M: 89TU16900AA

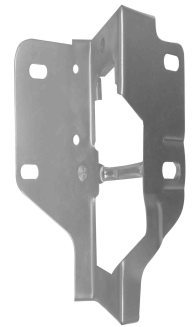

F-1000 até 1989
F-4000 até 1989

Cierre del capot - superior - sin cable

F-5242S
O&M: DOTB16700B

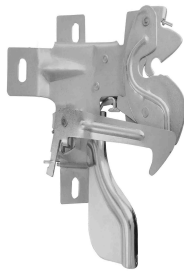

F-1000 até 1989
F-11000 até 1989
F-14000 até 1989
F-4000 até 1989
F-7000 até 1989

Cierre del capot - superior - con cable

F-5243S
O&M: 89TU16700AA

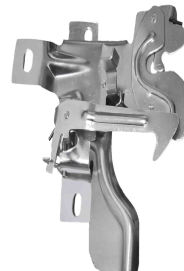

F-1000 1989 até 1992
F-11000 1989 até 1992
F-14000 1989 até 1992
F-4000 1989 até 1992
F-7000 1989 até 1992

MANUAL

Máquina levanta cristal - 2 puertas

R-5223D
O&M: BD3B98231WOO
R-5223E
O&M: BD3B98231WOI



F-75 1970 até 1982
Rural Willys 1956 até 1977

MANUAL

Máquina levanta cristal - 2 puertas

R-5141D
O&M: BD3C8123200A
R-5141E
O&M: BD3C8123201A



F-100 1972 até 1986
F-1000 1979 até 1991
F-11000 1981 até 1991
F-4000 1985 até 1991



MANUAL

Máquina levanta cristal - 2 puertas

R-5149D
O&M: T71837502D
R-5149E
O&M: T71837501D



F-1000 1992 até 1998 modelo Sapão
F-12000 1992 até 1998 modelo Sapão
F-14000 1992 até 1998 modelo Sapão
F-4000 1992 até 1998 modelo Sapão



MANUAL

Máquina levanta cristal - 2 puertas/4 puertas - delantero

R-5226D
O&M: XC3Z2523200AA
R-5226E
O&M: XC3Z2523201AA



F-12000 1999 até 2006 Pit Bull
F-14000 1999 até 2016 Pit Bull
F-16000 1999 até 2016 Pit Bull
F-250 1998 até 2012
F-350 1999 até 2010
F-4000 1998 até 2012



MANUAL

Máquina levanta cristal - 4 puertas - trasero

R-5247D
O&M: 8C3Z2627000A
R-5247E
O&M: 8C3Z2627001A



F-250 1998 até 2012
F-350 1999 até 2010
F-4000 1998 até 2012



MANUAL

Máquina levanta cristal - 2 puertas/4 puertas - delantero

R-5146D
O&M: F37Z1023200A
R-5146E
O&M: F37Z1023201A



Ranger 1994 até 2011



MANUAL

Máquina levanta cristal - 4 puertas - trasero

R-5154D
O&M: YL543527000AA
R-5154E
O&M: YL543527001AA



Ranger 1998 até 2011



ELECTRICA - S/MOTOR - motor inverso

Máquina levanta cristal - 2 puertas - Mabuchi (8 dientes)

R-5222D SM
O&M: 89TU81234W00B SM
R-5222E SM
O&M: 89TU81234W01B SM



F-1000 1979 até 1991
F-4000 1985 até 1991
F-600 1972 até 1979



ELECTRICA - S/MOTOR - motor inverso

Máquina levanta cristal - 2 puertas - Mabuchi (8 dientes)

R-5229D SM
O&M: 2SA837502A SM
R-5229E SM
O&M: 2SA837501A SM



F-1000 1992 até 1998 modelo Sapão
F-12000 1992 até 1998 modelo Sapão
F-14000 1992 até 1998 modelo Sapão
F-4000 1992 até 1998 modelo Sapão



ELECTRICA - S/MOTOR

Máquina levanta cristal - 2 puertas/4 puertas - delantero - Mabuchi (8 dientes)

R-5235D SM
O&M: XC3Z2523200BA SM
R-5235E SM
O&M: XC3Z2523201BA SM



F-12000 1999 até 2006 Pit Bull
F-14000 1999 até 2016 Pit Bull
F-16000 1999 até 2016 Pit Bull
F-250 1998 até 2012
F-350 1999 até 2010
F-4000 1998 até 2012



ELECTRICA - S/MOTOR

Máquina levanta cristal - trasero - Mabuchi (8 dientes)

R-5248D SM
O&M: 8C3Z2627000B SM
R-5248E SM
O&M: 8C3Z2627001B SM



F-250 1998 até 2012
F-350 1999 até 2010
F-4000 1998 até 2012

ELECTRICA - S/MOTOR - motor inverso

Máquina levanta cristal - 2 puertas/4 puertas - delantero - Mabuchi (8 dientes)

R-5147D SM
O&M: F57Z/1023208/AA SM
R-5147E SM
O&M: F57Z/1023209/AA SM



Ranger 1994 até 2011



ELECTRICA - S/MOTOR

Máquina levanta cristal - 4 puertas - trasero - Mabuchi (8 dientes)

R-5153D SM
O&M: 7L553527000AA SM
R-5153E SM
O&M: 7L553527001AA SM



Ranger 1998 até 2011



ELECTRICA - S/MOTOR

Máquina levanta cristal - 2 puertas/4 puertas - delantero - Mabuchi (8 dientes)

R-5227D SM
O&M: AB392123200BC SM
R-5227E SM
O&M: AB392123201BC SM



Ranger 2012 em diante



ELECTRICA - S/MOTOR

Máquina levanta cristal - 4 puertas - delantero - original (34 estrias)

R-5253D SM
O&M: AB392123200
R-5253E SM
O&M: AB392123201



Ranger 2012 em diante

ELECTRICA - S/MOTOR

Máquina levanta cristal - 4 puertas - trasero - Mabuchi (8 dientes)

R-5228D SM
O&M: AB392627000BC SM
R-5228E SM
O&M: AB392627001BC SM



Ranger 2012 em diante



ELECTRICA - S/MOTOR

Máquina levanta cristal - 4 puertas - trasero - original (32 estrias)

R-5157D SM
O&M: AB392627000BC/CCS SM
R-5157E SM
O&M: AB392627001BC/CCS SM



Ranger 2012 em diante



ELECTRICA - S/MOTOR

Máquina levanta cristal -
2 puertas/4 puertas -
delantero -
Mabuchi (8 dientes)

R-7519D SM
O&M: 698010K051 SM
R-7519E SM
O&M: 698020K051 SM



Hilux (picape e SW4) 2005 até
abr/2015



ELECTRICA - S/MOTOR - motor inverso

Máquina levanta
cristal - 4 puertas -
traseiro -
Mabuchi (8 dientes)

R-7520D SM
O&M: 698030K051 SM
R-7520E SM
O&M: 698040K051 SM



Hilux (picape e SW4) 2005 até
out/2015
Hilux (picape e SW4) SW4 2005
até nov/2015



ELECTRICA - S/MOTOR

Máquina levanta
cristal -
2 puertas/4 puertas -
delantero -
Mabuchi (8 dientes)

R-7540D SM
O&M: 698010K160 SM
R-7540E SM
O&M: 698020K160 SM



Hilux (picape e SW4) mai/2015
em diante



ELECTRICA - S/MOTOR - motor inverso

Máquina levanta
cristal - 4 puertas -
traseiro -
Mabuchi (8 dientes)

R-7541D SM
O&M: 698030K130 SM
R-7541E SM
O&M: 698040K130 SM



Hilux (picape e SW4) nov/2015
em diante
SW4 (2016 em diante) 2016 em
diante



MANUAL

Máquina levanta
cristal - 2 puertas -
pin cuadrado

R-2620D
O&M: 6980198001B
R-2620E
O&M: 6980298001B



Bandeirante 1967 até 1981

MANUAL

Máquina levanta
cristal - 2 puertas -
pin estriado

R-2621D
O&M: 6980198002A
R-2621E
O&M: 6980298002A



Bandeirante 1982 até 1983

MANUAL

Máquina levanta
cristal - 2 puertas -
pin estriado

R-2622D
O&M: 6980198003
R-2622E
O&M: 6980298003



Bandeirante 1984 até 2001

ELECTRICA - S/MOTOR

Máquina levanta
cristal - 4 puertas -
delantero -
Mabuchi (8 dientes)

R-7490D SM
O&M: MN182366 SM
R-7490E SM
O&M: MN182365 SM



L-200 Triton 2008 em diante

ELECTRICA - S/MOTOR - motor inverso

Máquina levanta
cristal - 4 puertas -
trasero -
Mabuchi (8 dientes)

R-7491D SM
O&M: MN182404 SM
R-7491E SM
O&M: MN182403 SM



L-200 Triton 2008 em diante

ELECTRICA - S/MOTOR

Máquina levanta
cristal - 4 puertas -
delantero -
Mabuchi (8 dientes)

R-7492D SM
O&M: MRI44530 SM
R-7492E SM
O&M: MRI44529 SM



L-200 Outdoor 2006 até 2011
L-200 Sport 2004 até 2011
Pajero Sport 2004 até 2011

MANUAL

Máquina levanta cristal -
2 puertas/4 puertas -
delantero

R-7799D
O&M: 80720Z710
R-7799E
O&M: 80721Z710



Frontier 1998 até 2007

ELECTRICA - S/MOTOR

Máquina levanta cristal -
2 puertas/4 puertas -
delantero -
original (8 dientes)

R-7802D SM
O&M: 80720EB71A SM
R-7802E SM
O&M: 80721EB71A SM

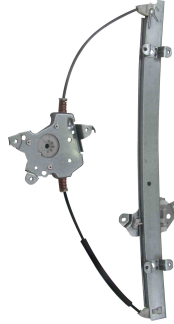

Frontier 2007 até 2019

ELECTRICA - S/MOTOR

Máquina levanta cristal - 4 puertas -
trasero -
original (eje cuadrado)

R-7803D SM
O&M: 82720JR20A SM
R-7803E SM
O&M: 82721JR20A SM

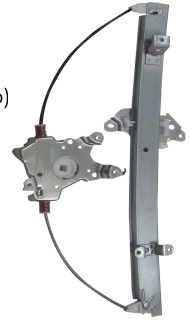

Frontier 2007 até 2019

ELECTRICA - S/MOTOR

Máquina levanta cristal -
2 puertas/4 puertas -
delantero -
Mabuchi (8 dientes)

R-7806D SM
O&M: 80720EB71A SM
R-7806E SM
O&M: 80721EB71A SM



Frontier 2007 até 2019

ELECTRICA - S/MOTOR

Máquina levanta cristal - 4 puertas -
trasero -
Mabuchi (8 dientes)

R-7807D SM
O&M: 82720JR20A SM
R-7807E SM
O&M: 82720JR20A SM



Frontier 2007 até 2019

ELECTRICA - S/MOTOR

Máquina levanta cristal - 4 puertas -
delantero -
Mabuchi (8 dientes)

R-7809D SM
O&M: 807214KH0A SM
R-7809E SM
O&M: 807204KH0A SM



Frontier 2021 em diante

MANUAL

Máquina levanta cristal



R-7702D
R-7702E

Maruá 2005 em diante

MANUAL

Máquina levanta cristal - 2 puertas

R-1424D
O&M: 2997185
R-1424E
O&M: 2997186



Cavallino 320 1998 em diante
Eurocargo 1998 em diante
Stralis 1998 em diante
Tector 1998 em diante



MANUAL

Máquina levanta cristal - 2 puertas

R-1501D
O&M: 5949891222
R-1501E
O&M: 5949891263

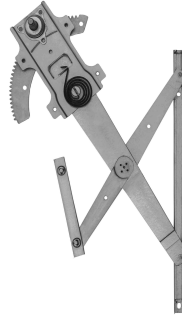

Vertis 2011 em diante



ELECTRICA - S/MOTOR

Máquina levanta cristal - 2 puertas - Mabuchi (8 dientes)

R-1445D SM
O&M: 2997195RH SM
R-1445E SM
O&M: 2997196LH SM



Cavallino 320 1998 em diante
Eurocargo 1998 em diante
Stralis 1998 em diante
Tector 1998 em diante



ELECTRICA - S/MOTOR

Máquina levanta cristal - original (32 estrías)

R-1453D SM
O&M: 504040988
R-1453E SM
O&M: 504040989



Cavallino 320 1998 em diante
Eurocargo 1998 em diante
Stralis 1998 em diante
Tector 1998 em diante



ELECTRICA - S/MOTOR

Máquina levanta cristal - 2 puertas - Mabuchi (8 dientes)

R-1446D SM
O&M: 5949891164 SM
R-1446E SM
O&M: 5949891165 SM



Vertis 2011 em diante



Cerradura de puerta



F-2300D
O&M: A3087207135
F-2300E
O&M: A3087207035

608 1983 até 1990

Cerradura de puerta



F-2301D
O&M: A3447207135
F-2301E
O&M: A3447207035

1111 / 1113 / 1313 / 1513 / 2013 / 2213 até 1990

Cerradura de puerta - interna



F-2303D
O&M: 6887207135
F-2303E
O&M: 6887207035

709 até 1996

Cierre del capot - inferior



F-2302I
O&M: 3328800060

1111 / 1113 / 1313 / 1513 / 2013 / 2213 até 1990

Cierre del capot - superior



F-2302S
O&M: 3328800160

1111 / 1113 / 1313 / 1513 / 2013 / 2213 até 1990

Cierre del capot - inferior

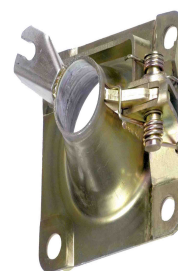

F-2309I
O&M: A3848807660INF

1214 / 1618 / HPN até 2000

Cierre del capot - superior



F-2309S
O&M: A3848807660SUP

1214 / 1618 / HPN até 2000

Cierre del capot - inferior



F-2306I
O&M: A6948800260INF

1418 / 1620 / HPN 2001 em diante

Cierre del capot - superior



F-2306S
O&M: A6948800160SUP

1418 / 1620 / HPN 2001 em diante

MANUAL

Máquina levanta cristal - 2 puertas - pin bajo



R-2121D
O&M: 3447680101
R-2121E
O&M: 3447680001

1111 / 1113 / 1313 / 1513 / 2013 / 2213
1973 até 1982



MANUAL

Máquina levanta cristal - 2 puertas - pin alto



R-2122D
O&M: 3317257202
R-2122E
O&M: 3317257302

1111 / 1113 / 1313 / 1513 / 2013 / 2213
1983 até 1990



MANUAL

Máquina levanta cristal - 2 puertas



R-2125D
O&M: A3086707303
R-2125E
O&M: A3086707203

608 1983 até 1990



MANUAL

Máquina levanta cristal - 2 puertas - pin alto - exportación

R-2124D
O&M: 3817250102
R-2124E
O&M: 3817250002



Zetros / Unimog

MANUAL

Máquina levanta cristal - 2 puertas - pin alto

R-2123D
O&M: 6887207146
R-2123E
O&M: 6887207046



507 / 809 / 811 / 909 / 1938 1991
até 2000



MANUAL

Máquina levanta cristal - 2 puertas

R-2120D
O&M: 6887207646
R-2120E
O&M: 6887207546



1935 / 1938 / 1218 / 1418 2001 em
diante
709 2001 em diante



MANUAL

Máquina levanta cristal - 2 puertas - pin bajo

R-2307D
O&M: 9737200246
R-2307E
O&M: 9737200146



1938S 2006 em diante
Atego 2006 em diante
Axor 2006 em diante



MANUAL

Máquina levanta cristal - 2 puertas - pin alto

R-2314D
O&M: 9737200246
R-2314E
O&M: 9737200146



1938S 2006 em diante
Atego 2006 em diante
Axor 2006 em diante



MANUAL

Máquina levanta cristal - 2 puertas - delantero

R-2316D
O&M: A9797207046
R-2316E
O&M: A9797207146



Acello 715 / 915 2002 até 2011



MANUAL

Máquina levanta cristal - 2 puertas

R-2308D
O&M: 9797201246
R-2308E
O&M: 9797201146



Acello 1016 2012 em diante
Acello 815 2012 em diante



MANUAL

Máquina levanta cristal - exportación

R-2305D
R-2305E



MB Alemão

ELECTRICA - S/MOTOR

Máquina levanta cristal - 2 puertas - Bosch (10 dientes)

R-2310D SM
O&M: 7200446 SM
R-2310E SM
O&M: 9797200346 SM



1938S 2006 em diante
Atego 2006 em diante
Axor 2006 em diante



ELECTRICA - S/MOTOR - motor inverso

Máquina levanta cristal - 2 puertas - Mabuchi (8 dientes)

R-2312D SM
O&M: 9797200446 SM
R-2312E SM
O&M: 9797200346 SM



1938S 2006 em diante
Atego 2006 em diante
Axor 2006 em diante



ELECTRICA - S/MOTOR

Máquina levanta cristal - Brose (32 estrías)

R-2315D SM
O&M: 9797200446
R-2315E SM
O&M: 9797200346



1938S 2006 em diante
Atego 2006 em diante
Axor 2006 em diante



ELECTRICA - S/MOTOR - motor inverso

Máquina levanta cristal - 2 puertas - Mabuchi (8 dientes)

R-2126D SM
O&M: A3847207146 SM
R-2126E SM
O&M: A3847207046 SM



HPN 709 / 1935 1991 até 2000



ELECTRICA - S/MOTOR - motor inverso

Máquina levanta cristal - 2 puertas - Mabuchi (8 dientes)



R-2128D SM
O&M: 6967200146 SM
R-2128E SM
O&M: 6967200246 SM

Atron 2001 em diante
HPN 709 / 1935 2001 em diante



ELECTRICA - S/MOTOR

Máquina levanta cristal - 2 puertas - Mabuchi (8 dientes)



R-2129D SM
O&M: 3317257202 SM
R-2129E SM
O&M: 3317257302 SM

1111 / 1113 / 1313 / 1513 / 2013 / 2213
até 1990



ELECTRICA - S/MOTOR - motor inverso

Máquina levanta cristal - 2 puertas - Mabuchi (8 dientes)



R-2311D SM
O&M: 9797200246 SM
R-2311E SM
O&M: 9797200146 SM

Acello 715 / 915 2002 até 2011
Acello 915 2002 até 2011



ELECTRICA - S/MOTOR - motor inverso

Máquina levanta cristal - 2 puertas - Mabuchi (8 dientes)



R-2313D SM
O&M: 9797200946 SM
R-2313E SM
O&M: 9797200846 SM

Acello 1016 2012 em diante
Acello 815 2012 em diante



MANUAL

Máquina levanta cristal - 2 puertas - con ventilete



R-2601D
O&M: 66736
R-2601E
O&M: 66735

L75 / L76 1970 até 1974

MANUAL

Máquina levanta cristal - 2 puertas - sin ventilete

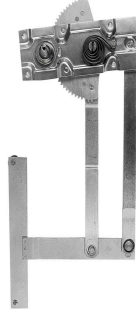

R-2602D
O&M: 236256
R-2602E
O&M: 236255

L110 / L111 1975 até 1980

MANUAL

Máquina levanta cristal - 2 puertas



R-2603D
O&M: 296430
R-2603E
O&M: 296429

T / R 112 1981 até 1987



MANUAL

Máquina levanta cristal - 2 puertas



R-2604D
O&M: 524784
R-2604E
O&M: 524783

T / R 113 1988 até 1997



MANUAL

Máquina levanta cristal - 2 puertas



R-2605D
O&M: 187720
R-2605E
O&M: 187719

LK140 / LK141 1988 em diante

MANUAL

Máquina levanta cristal - 2 puertas



R-2606D
O&M: 1366848
R-2606E
O&M: 1366847

Série 4 / 5 / 6 T-R-P-G 1998 em diante



ELECTRICA - S/MOTOR

Máquina levanta cristal - 2 puertas - original (10 dientes)



R-2608D SM
O&M: 376674 SM
R-2608E SM
O&M: 376673 SM

Série 3 R112 / R113 / T112 / T113 1981 até 1997



ELECTRICA - S/MOTOR

Máquina levanta cristal - 2 puertas - Bosch (10 dientes)



R-2607D SM
O&M: 1442294 SM
R-2607E SM
O&M: 1442295 SM

Série 4 / 5 / 6 T-R-P-G 1998 em diante



VOLVO

Cerradura de puerta



F-2915D
O&M: 8123612
F-2915E
O&M: 8123611

NL10 / NL12 / EDC 1992 até 1999

MANUAL

Máquina levanta cristal - 2 puertas



R-2610D
O&M: 6889224
R-2610E
O&M: 6889223

N / NL cabina corta 1983 até 1989

MANUAL

Máquina levanta cristal - 2 puertas



R-2611D
O&M: 8123658
R-2611E
O&M: 8123657

NL10 / NL12 / EDC cabina larga 1992 até 1999



MANUAL

Máquina levanta cristal - 2 puertas



R-2612D
O&M: 8123248
R-2612E
O&M: 8123247

NL10 / NL12 cabina normal 1990 até 1994

MANUAL

Máquina levanta cristal - 2 puertas



R-2617D
O&M: 3176542
R-2617E
O&M: 3176541

FM / FH12 / FH13 1994 em diante



MANUAL

Máquina levanta cristal - 2 puertas



R-2616D
O&M: 20557550
R-2616E
O&M: 20557548

VM 2004 em diante



ELECTRICA - S/MOTOR

Máquina levanta cristal - 2 puertas - Mabuchi (8 dientes)



R-2613D SM
O&M: 8123550 SM
R-2613E SM
O&M: 8123551 SM

NL10 / NL12 / EDC cabina larga 1992 até 1999



ELECTRICA - S/MOTOR

Máquina levanta cristal - 2 puertas - original (10 dientes)



R-2615D SM
O&M: 3176546 SM
R-2615E SM
O&M: 3176545 SM

FM / FH12 / FH13 1994 em diante



ELECTRICA - S/MOTOR

Máquina levanta cristal - 2 puertas - original (cuadrado)



R-2618D SM
O&M: 20557554 SM
R-2618E SM
O&M: 20557552 SM

VM 2004 em diante



ELECTRICA - S/MOTOR

Máquina levanta cristal - 2 puertas - Mabuchi (8 dientes)



R-2614D SM
O&M: 20557554 SM
R-2614E SM
O&M: 20557552 SM

VM 2004 em diante



VOLVO

Bisagra tapa
delantera - con
resorte

D-3383D
O&M: 7362032
D-3383E
O&M: 7362031



A-10 até 1984
C-10 até 1984
D-10 até 1984

Bisagra tapa
delantera - con
resorte

D-3384D
O&M: 94630704
D-3384E
O&M: 94630703



C-20 1985 em diante
D-20 1985 em diante
D-40 1985 em diante

Bisagra tapa
delantera - soporte

S-3385



A-10 até 1984
C-10 até 1984
D-10 até 1984

MANUAL

Máquina levanta
cristal - 2 puertas -
delantero

R-3114D
O&M: 7320092
R-3114E
O&M: 7320091



C-10 1972 até 1985
D-10 1979 até 1985
D-60 1965 até 1985
Veraneio 1971 até 1985



MANUAL

Máquina levanta
cristal - 2 puertas

R-3116D
O&M: 94637552
R-3116E
O&M: 94637551



A-20 1985 até 1990
A-40 1985 até 1990
C-20 1985 até 1990
D-20 1985 até 1990
D-40 1985 até 1990



MANUAL

Máquina levanta
cristal -
2 puertas/4 puertas -
delantero

R-3346D
O&M: 52255122
R-3346E
O&M: 52255121



A-20 1991 até 1996
A-40 1991 até 1996
Bonanza 1991 até 1994
C-20 1991 até 1996
D-12000 1991 até 1996
D-20 1991 até 1996
D-40 1991 até 1996
Veraneio 1991 até 1994



MANUAL

Máquina levanta
cristal - 4 puertas -
trasero

R-3347D
O&M: 52255126
R-3347E
O&M: 52255125



A-20 1991 até 1996
A-40 1991 até 1996
Bonanza 1991 até 1994
C-20 1991 até 1996
D-12000 1991 até 1996
D-20 1991 até 1996
D-40 1991 até 1996
Veraneio 1991 até 1994



ELECTRICA - S/MOTOR - motor inverso

Máquina levanta
cristal - 4 puertas -
delantero -
Mabuchi (8 dientes)

R-3332D SM
O&M: 52255124 SM
R-3332E SM
O&M: 52255123 SM



A-20 1991 até 1996
Bonanza 1991 até 1994
C-20 1991 até 1996
D-20 1991 até 1996
Veraneio 1991 até 1994



ELECTRICA - S/MOTOR

Máquina levanta
cristal - 4 puertas -
trasero -
Mabuchi (8 dientes)

R-3333D SM
O&M: 52255128 SM
R-3333E SM
O&M: 52255127 SM



A-20 1991 até 1996
Bonanza 1991 até 1994
C-20 1991 até 1996
D-20 1991 até 1996
Veraneio 1991 até 1994



VOLKSWAGEN

Cerradura de puerta - delantero

F-4498D
O&M: 2318370161
F-4498E
O&M: 2318370151



Kombi Clipper 1976 até 1996
Worker / Titan / Tractor 1980 em diante

MANUAL

Máquina levanta cristal - 2 puertas - de tornillo - pin más bajo

R-4162D
O&M: TO0837502
R-4162E
O&M: TO0837501



Worker / Titan / Tractor 1980 até 1989

MANUAL

Máquina levanta cristal - 2 puertas - de tornillo - pin bajo

R-4160D
O&M: TF3837502
R-4160E
O&M: TF3837501



Worker / Titan / Tractor 1990 até 1996

MANUAL

Máquina levanta cristal - 2 puertas - de pinza - pin medio

R-4161D
O&M: 2RD837502
R-4161E
O&M: 2RD837501



Worker / Titan / Tractor 1997 até 2000

MANUAL

Máquina levanta cristal - 2 puertas - de pinza - pin alto

R-4163D
O&M: 2VC837502
R-4163E
O&M: 2VC837501



Worker / Titan / Tractor 2001 em diante

MANUAL

Máquina levanta cristal - 2 puertas

R-4188D
O&M: 2R2837398
R-4188E
O&M: 2R2837397



Constellation 2005 em diante

MANUAL

Máquina levanta cristal

R-4402D
O&M: 23B837502
R-4402E
O&M: 23B837501



Delivery 11.180 2017 em diante
Delivery 13.180 2017 em diante
Delivery 4.150 2017 em diante
Delivery 6.160 2017 em diante
Delivery 9.170 2017 em diante
Delivery Express 2017 em diante

ELECTRICA - S/MOTOR

Máquina levanta cristal - 2 puertas - Mabuchi (8 dientes)

R-4195D SM
O&M: TF3837502 SM
R-4195E SM
O&M: TF3837501 SM



Worker / Titan / Tractor 1980 em diante

ELECTRICA - S/MOTOR - motor inverso

Máquina levanta cristal - 2 puertas - Mabuchi (8 dientes)

R-4196D SM
O&M: 2R2837400 SM
R-4196E SM
O&M: 2R2837399 SM



Constellation 2005 em diante

ELECTRICA - S/MOTOR

Máquina levanta cristal - Mabuchi (8 dientes)

R-4403D SM
O&M: 23B837400
R-4403E SM
O&M: 23B837399

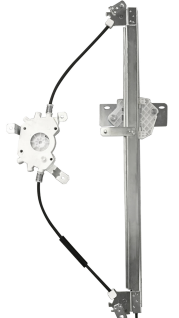

Delivery 11.180 2017 em diante
Delivery 13.180 2017 em diante
Delivery 4.150 2017 em diante
Delivery 6.160 2017 em diante
Delivery 9.170 2017 em diante
Delivery Express 2017 em diante

ELECTRICA - S/MOTOR

Máquina levanta cristal - original (32 estrías)

R-4404D SM
O&M: 23B837400
R-4404E SM
O&M: 23B837399



Delivery 11.180 2017 em diante
Delivery 13.180 2017 em diante
Delivery 4.150 2017 em diante
Delivery 6.160 2017 em diante
Delivery 9.170 2017 em diante
Delivery Express 2017 em diante

Motor de máquina levanta cristal - original (32 estrías) - 12v

M-6706D
O&M: F006B40719
M-6706E
O&M: F006B40718



Delivery 4.150 2017 em diante
Delivery 6.160 2017 em diante
Delivery Express 2017 em diante

VOLKSWAGEN

Motor de máquina
levanta cristal -
original (32 estrías) -
24v

M-6707D 24V
M-6707E 24V



Delivery 11.180 2017 em diante
Delivery 13.180 2017 em diante
Delivery 9.170 2017 em diante



FORD

Bisagra tapa delantera - con resorte



D-5240D
O&M: 90TU16900BA
D-5240E
O&M: 90TU16801BA

F-11000 até 1991
F-13000 até 1989
F-600 até 1991

Bisagra tapa delantera



D-5241D
O&M: T75823306A
D-5241E
O&M: T75823305A

F-12000 1993 até 1998 modelo Sapão
F-12000 L 1993 até 1998 modelo Sapão
F-14000 HD 1993 até 1998 modelo Sapão

Bisagra tapa delantera - con resorte



D-5238D
O&M: 90TU16800A
D-5238E
O&M: 90TU16801A

F-1000 até 1992
F-4000 até 1992

Bisagra tapa delantera - con resorte



D-5239D
O&M: TNK823335
D-5239E
O&M: EITQ16796A

F-1000 1992 até 1998
F-4000 1992 até 1998

Cierre del capot - inferior

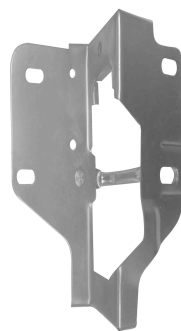

F-5242I
O&M: 89TU16900AA

F-1000 até 1989
F-4000 até 1989

Cierre del capot - superior - sin cable

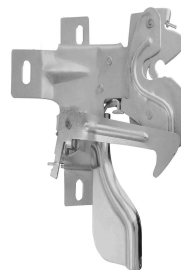

F-5242S
O&M: DOTB16700B

F-1000 até 1989
F-11000 até 1989
F-14000 até 1989
F-4000 até 1989
F-7000 até 1989

Cierre del capot - superior - con cable



F-5243S
O&M: 89TU16700AA

F-1000 1989 até 1992
F-11000 1989 até 1992
F-14000 1989 até 1992
F-4000 1989 até 1992
F-7000 1989 até 1992

Cierre del capot - inferior



F-5244I
O&M: C7TZ16892B

F-11000
F-600

MANUAL

Máquina levanta cristal - 2 puertas



R-5223D
O&M: BD3B98231W00
R-5223E
O&M: BD3B98231W01

F-75 1970 até 1982
Rural Willys 1956 até 1977

MANUAL

Máquina levanta cristal - 2 puertas



R-5141D
O&M: BD3C8123200A
R-5141E
O&M: BD3C8123201A

F-100 1972 até 1986
F-1000 1979 até 1991
F-11000 1981 até 1991
F-4000 1985 até 1991



MANUAL

Máquina levanta cristal - 2 puertas



R-5149D
O&M: T71837502D
R-5149E
O&M: T71837501D

F-1000 1992 até 1998 modelo Sapão
F-12000 1992 até 1998 modelo Sapão
F-14000 1992 até 1998 modelo Sapão
F-4000 1992 até 1998 modelo Sapão



MANUAL

Máquina levanta cristal - 2 puertas/4 puertas - delantero



R-5226D
O&M: XC3Z2523200AA
R-5226E
O&M: XC3Z2523201AA

F-12000 1999 até 2006 Pit Bull
F-14000 1999 até 2016 Pit Bull
F-16000 1999 até 2016 Pit Bull
F-250 1998 até 2012
F-350 1999 até 2010
F-4000 1998 até 2012



FORD

MANUAL

Máquina levanta cristal - 4 puertas - trasero



R-5247D
O&M: 8C3Z2627000A
R-5247E
O&M: 8C3Z2627001A

F-250 1998 até 2012
F-350 1999 até 2010
F-4000 1998 até 2012

ELECTRICA - S/MOTOR - motor inverso

Máquina levanta cristal - 2 puertas - Mabuchi (8 dientes)



R-5222D SM
O&M: 89TU81234W00B SM
R-5222E SM
O&M: 89TU81234W01B SM

F-1000 1979 até 1991
F-4000 1985 até 1991
F-600 1972 até 1979



ELECTRICA - S/MOTOR - motor inverso

Máquina levanta cristal - 2 puertas - Mabuchi (8 dientes)



R-5229D SM
O&M: 2SA837502A SM
R-5229E SM
O&M: 2SA837501A SM

F-1000 1992 até 1998 modelo Sapão
F-12000 1992 até 1998 modelo Sapão
F-14000 1992 até 1998 modelo Sapão
F-4000 1992 até 1998 modelo Sapão



ELECTRICA - S/MOTOR

Máquina levanta cristal - 2 puertas/4 puertas - delantero - Mabuchi (8 dientes)



R-5235D SM
O&M: XC3Z2523200BA SM
R-5235E SM
O&M: XC3Z2523201BA SM

F-12000 1999 até 2006 Pit Bull
F-14000 1999 até 2016 Pit Bull
F-16000 1999 até 2016 Pit Bull
F-250 1998 até 2012
F-350 1999 até 2010
F-4000 1998 até 2012



ELECTRICA - S/MOTOR

Máquina levanta cristal - 4 puertas - trasero - Mabuchi (8 dientes)



R-5248D SM
O&M: 8C3Z2627000B SM
R-5248E SM
O&M: 8C3Z2627001B SM

F-250 1998 até 2012
F-350 1999 até 2010
F-4000 1998 até 2012

MANUAL

Máquina levanta cristal - 2 puertas



R-5148D
O&M: 81DBE23200AJ / 9C457023200AA
R-5148E
O&M: 81DBE23201AH / 9C457023201AA

Cargo 1981 até 2012



ELECTRICA - S/MOTOR

Máquina levanta cristal - 2 puertas - Mabuchi (8 dientes)



R-5233D SM
O&M: 81DBE23200AJ SM
R-5233E SM
O&M: 81DBE23201AJ SM

Cargo 1981 até 2013

ELECTRICA - S/MOTOR

Máquina levanta cristal - 2 puertas - Mabuchi (8 dientes)

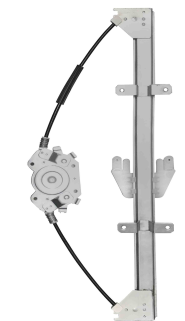

R-5249D SM
O&M: 3C46E23200BE SM
R-5249E SM
O&M: 3C46E23201BE SM

Cargo 2011 em diante



ELECTRICA - S/MOTOR

Máquina levanta cristal - 2 puertas - Bosch (32 estrías)



R-5237D SM
O&M: 3C46E23200BE SM
R-5237E SM
O&M: 3C46E23201BE SM

Cargo 2011 em diante



ELECTRICA - S/MOTOR

Máquina levanta cristal - 2 puertas - original (32 estrías)

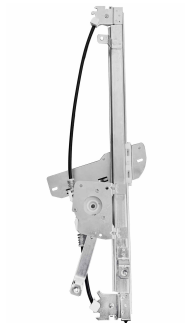

R-5252D SM
O&M: EC457023200BB
R-5252E SM
O&M: EC457023201BB

Cargo C-816 / C-1119 2013 em diante



ELECTRICA - S/MOTOR

Máquina levanta
cristal - 2 puertas -
delantero -
Mabuchi (8 dientes)

R-7535D SM
O&M: 815025h100 SM
R-7535E SM
O&M: 815015h100 SM

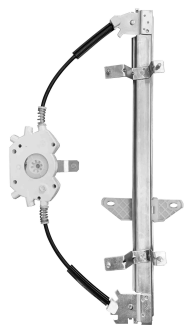

HD80 2019 em diante

MANUAL

Máquina levanta cristal

R-7701D
R-7701E



13000 2007 até 2012
8500 2007 até 2012
9200 2004 até 2012
Buses Agrale 2004 em diante

MANUAL

Máquina levanta cristal - 2 portas - delantero

R-7703D
R-7703E



Agrale GIII 8700 / 10000 / 14000 2012 em diante

ELECTRICA - S/MOTOR - motor inverso

Máquina levanta cristal - 2 portas - delantero - Mabuchi (8 dientes)

R-7705D SM
O&M: 6023011052004
R-7705E SM
O&M: 6023011053002



Agrale GIII 8700/1400 2012 em diante

Cerradura de puerta

F-2655D
O&M: 27242687
F-2655E
O&M: 27242686

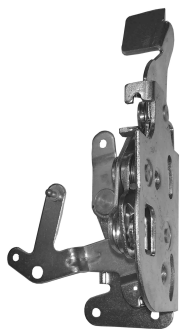

G6 1996 até 2009

MANUAL
Máquina levanta
cristal

R-2656D
R-2656E



versão nova

MANUAL
Máquina levanta
cristal

R-2657D
R-2657E



2122

MANUAL
Máquina levanta
cristal

R-2658D
R-2658E



2603

MANUAL

Máquina levanta cristal - 2 puertas - pin cuadrado

R-2599E
O&M: 218000569



RK424 / RK424B

MANUAL

Máquina levanta cristal - 2 puertas - pin estriado

R-2600D
R-2600E
O&M: 21800206



RK424 / RK424B

PACCAR

ELECTRICA - S/MOTOR

Máquina levanta
cristal - 2 puertas -
delantero -
Mabuchi (8 dientes)

R-2703D SM
O&M: 6EA839462
R-2703E SM
O&M: 6EA839461



Daf CF85 2003 até 2021

PACCAR

Motor de máquina levanta cristal - Mabuchi (8 dientes) - 12v - látigo gris

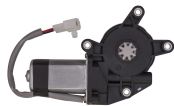

M-6700D
M-6700E

Motor de máquina levanta cristal - Mabuchi (8 dientes) - 24v



M-6701D
M-6701E

Motor de máquina levanta cristal - original (10 dientes) - 24v - p/Scania S4 e Volvo FH



M-6702D
O&M: 1442293
M-6702E
O&M: 1442292

Motor de máquina levanta cristal - original (10 dientes) - 24v - p/Scania S3

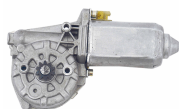

M-6703D
M-6703E

Motor de máquina levanta cristal - original (9 dientes) - 24v - p/Actros 2546/2646/2651



M-6704D
O&M: 0008205008
M-6704E
O&M: 0008204908

Motor de máquina levanta cristal - original (32 estrías) - 12v



M-6705D
O&M: 94773649
M-6705E
O&M: 94773650

Cobalt 2011 em diante
Spin 2012 em diante

Motor de máquina levanta cristal - original (32 estrías) - 12v



M-6706D
O&M: F006B40719
M-6706E
O&M: F006B40718

Delivery 4.150 2017 em diante
Delivery 6.160 2017 em diante
Delivery Express 2017 em diante



Motor de máquina levanta cristal - original (32 estrías) - 24v



M-6707D 24V
M-6707E 24V

Delivery 11.180 2017 em diante
Delivery 13.180 2017 em diante
Delivery 9.170 2017 em diante





Est. Água Chata, 1233, Bonsucesso
Guarulhos, SP - CEP 07251-000
(11) 2088-7200