

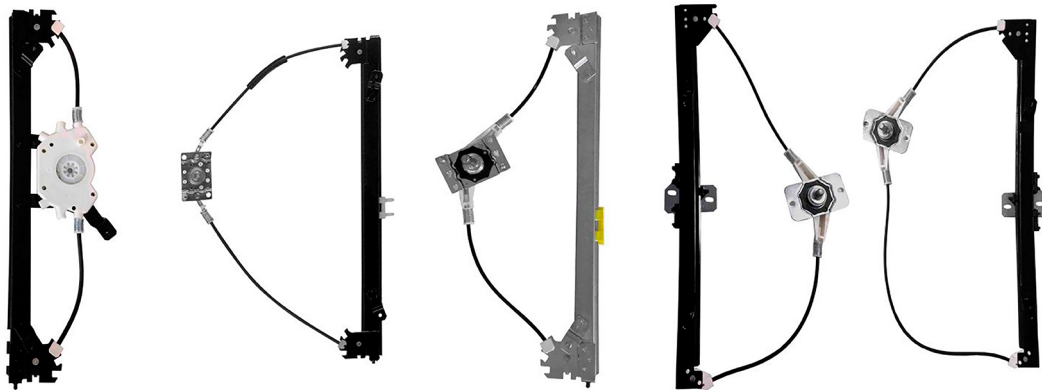

Zinni & Güell

Indústria de Auto Peças Ltda.



LINEA PESADA

SIN MÁQUINAS LEVANTA CRISTAL ELECTRICAS CON MOTOR



Canal de YouTube - pionero con consejos e instalaciones de productos

● GM	1
● VOLKSWAGEN	2
● FORD	4
● HYUNDAI	6
● IVECO	7
● MERCEDES-BENZ	8
● SCANIA	11
● VOLVO	12
● AGRALE	13
● MARCOPOLO	14
● RANDON	15
PACCAR	16

Bisagra tapa
delantera - con
resorte

D-3383D
O&M: 7362032
D-3383E
O&M: 7362031



A-10 até 1984
C-10 até 1984
D-10 até 1984

Bisagra tapa
delantera - con
resorte

D-3384D
O&M: 94630704
D-3384E
O&M: 94630703



C-20 1985 em diante
D-20 1985 em diante
D-40 1985 em diante

Bisagra tapa
delantera - soporte

S-3385



A-10 até 1984
C-10 até 1984
D-10 até 1984

MANUAL

Máquina levanta
cristal - 2 puertas -
delantero

R-3114D
O&M: 7320092
R-3114E
O&M: 7320091



C-10 1972 até 1985
D-10 1979 até 1985
D-60 1965 até 1985
Veraneio 1971 até 1985



MANUAL

Máquina levanta
cristal - 2 puertas

R-3116D
O&M: 94637552
R-3116E
O&M: 94637551



A-20 1985 até 1990
A-40 1985 até 1990
C-20 1985 até 1990
D-20 1985 até 1990
D-40 1985 até 1990



MANUAL

Máquina levanta
cristal -
2 puertas/4 puertas -
delantero

R-3346D
O&M: 52255122
R-3346E
O&M: 52255121



A-20 1991 até 1996
A-40 1991 até 1996
Bonanza 1991 até 1994
C-20 1991 até 1996
D-12000 1991 até 1996
D-20 1991 até 1996
D-40 1991 até 1996
Veraneio 1991 até 1994



MANUAL

Máquina levanta
cristal - 4 puertas -
trasero

R-3347D
O&M: 52255126
R-3347E
O&M: 52255125



A-20 1991 até 1996
A-40 1991 até 1996
Bonanza 1991 até 1994
C-20 1991 até 1996
D-12000 1991 até 1996
D-20 1991 até 1996
D-40 1991 até 1996
Veraneio 1991 até 1994



ELECTRICA - S/MOTOR - motor inverso

Máquina levanta
cristal - 4 puertas -
delantero -
Mabuchi (8 dientes)

R-3332D SM
O&M: 52255124 SM
R-3332E SM
O&M: 52255123 SM



A-20 1991 até 1996
Bonanza 1991 até 1994
C-20 1991 até 1996
D-20 1991 até 1996
Veraneio 1991 até 1994



ELECTRICA - S/MOTOR

Máquina levanta
cristal - 4 puertas -
trasero -
Mabuchi (8 dientes)

R-3333D SM
O&M: 52255128 SM
R-3333E SM
O&M: 52255127 SM



A-20 1991 até 1996
Bonanza 1991 até 1994
C-20 1991 até 1996
D-20 1991 até 1996
Veraneio 1991 até 1994



VOLKSWAGEN

Cerradura de puerta - delantero

F-4498D
O&M: 2318370161
F-4498E
O&M: 2318370151



Kombi Clipper 1976 até 1996
Worker / Titan / Tractor 1980 em diante

MANUAL

Máquina levanta cristal - 2 puertas - de tornillo - pin más bajo

R-4162D
O&M: TOO837502
R-4162E
O&M: TOO837501



Worker / Titan / Tractor 1980 até 1989

MANUAL

Máquina levanta cristal - 2 puertas - de tornillo - pin bajo

R-4160D
O&M: TF3837502
R-4160E
O&M: TF3837501



Worker / Titan / Tractor 1990 até 1996

MANUAL

Máquina levanta cristal - 2 puertas - de pinza - pin medio

R-4161D
O&M: 2RD837502
R-4161E
O&M: 2RD837501



Worker / Titan / Tractor 1997 até 2000

MANUAL

Máquina levanta cristal - 2 puertas - de pinza - pin alto

R-4163D
O&M: 2VC837502
R-4163E
O&M: 2VC837501



Worker / Titan / Tractor 2001 em diante

MANUAL

Máquina levanta cristal - 2 puertas

R-4188D
O&M: 2R2837398
R-4188E
O&M: 2R2837397



Constellation 2005 em diante

MANUAL

Máquina levanta cristal

R-4402D
O&M: 23B837502
R-4402E
O&M: 23B837501



Delivery 11.180 2017 em diante
Delivery 13.180 2017 em diante
Delivery 4.150 2017 em diante
Delivery 6.160 2017 em diante
Delivery 9.170 2017 em diante
Delivery Express 2017 em diante

ELECTRICA - S/MOTOR

Máquina levanta cristal - 2 puertas - Mabuchi (8 dientes)

R-4195D SM
O&M: TF3837502 SM
R-4195E SM
O&M: TF3837501 SM

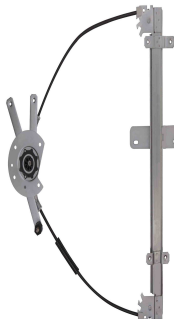

Worker / Titan / Tractor 1980 em diante

ELECTRICA - S/MOTOR - motor inverso

Máquina levanta cristal - 2 puertas - Mabuchi (8 dientes)

R-4196D SM
O&M: 2R2837400 SM
R-4196E SM
O&M: 2R2837399 SM



Constellation 2005 em diante

ELECTRICA - S/MOTOR

Máquina levanta cristal - Mabuchi (8 dientes)

R-4403D SM
O&M: 23B837400
R-4403E SM
O&M: 23B837399

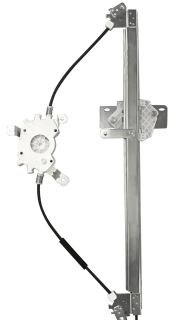

Delivery 11.180 2017 em diante
Delivery 13.180 2017 em diante
Delivery 4.150 2017 em diante
Delivery 6.160 2017 em diante
Delivery 9.170 2017 em diante
Delivery Express 2017 em diante

ELECTRICA - S/MOTOR

Máquina levanta cristal - original (32 estrías)

R-4404D SM
O&M: 23B837400
R-4404E SM
O&M: 23B837399



Delivery 11.180 2017 em diante
Delivery 13.180 2017 em diante
Delivery 4.150 2017 em diante
Delivery 6.160 2017 em diante
Delivery 9.170 2017 em diante
Delivery Express 2017 em diante

Motor de máquina levanta cristal - original (32 estrías) - 12v

M-6706D
O&M: F006B40719
M-6706E
O&M: F006B40718



Delivery 4.150 2017 em diante
Delivery 6.160 2017 em diante
Delivery Express 2017 em diante

VOLKSWAGEN

Motor de máquina
levanta cristal -
original (32 estrías) -
24v

M-6707D 24V
M-6707E 24V



Delivery 11.180 2017 em diante
Delivery 13.180 2017 em diante
Delivery 9.170 2017 em diante



FORD

Bisagra tapa delantera - con resorte



D-5240D
O&M: 90TU16900BA
D-5240E
O&M: 90TU16801BA

F-11000 até 1991
F-13000 até 1989
F-600 até 1991

Bisagra tapa delantera



D-5241D
O&M: T75823306A
D-5241E
O&M: T75823305A

F-12000 1993 até 1998 modelo Sapão
F-12000 L 1993 até 1998 modelo Sapão
F-14000 HD 1993 até 1998 modelo Sapão

Bisagra tapa delantera - con resorte



D-5238D
O&M: 90TU16800A
D-5238E
O&M: 90TU16801A

F-1000 até 1992
F-4000 até 1992

Bisagra tapa delantera - con resorte



D-5239D
O&M: TNK823335
D-5239E
O&M: EITQ16796A

F-1000 1992 até 1998
F-4000 1992 até 1998

Cierre del capot - inferior

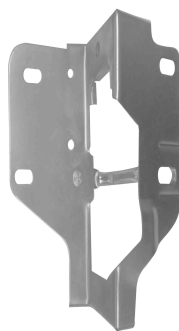

F-5242I
O&M: 89TU16900AA

F-1000 até 1989
F-4000 até 1989

Cierre del capot - superior - sin cable

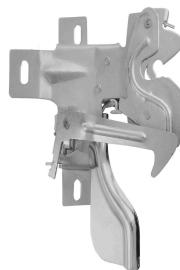

F-5242S
O&M: DOTB16700B

F-1000 até 1989
F-11000 até 1989
F-14000 até 1989
F-4000 até 1989
F-7000 até 1989

Cierre del capot - superior - con cable



F-5243S
O&M: 89TU16700AA

F-1000 1989 até 1992
F-11000 1989 até 1992
F-14000 1989 até 1992
F-4000 1989 até 1992
F-7000 1989 até 1992

Cierre del capot - inferior



F-5244I
O&M: C7TZ16892B

F-11000
F-600

MANUAL

Máquina levanta cristal - 2 puertas



R-5223D
O&M: BD3B98231W00
R-5223E
O&M: BD3B98231W01

F-75 1970 até 1982
Rural Willys 1956 até 1977

MANUAL

Máquina levanta cristal - 2 puertas



R-5141D
O&M: BD3C8123200A
R-5141E
O&M: BD3C8123201A

F-100 1972 até 1986
F-1000 1979 até 1991
F-11000 1981 até 1991
F-4000 1985 até 1991



MANUAL

Máquina levanta cristal - 2 puertas



R-5149D
O&M: T71837502D
R-5149E
O&M: T71837501D

F-1000 1992 até 1998 modelo Sapão
F-12000 1992 até 1998 modelo Sapão
F-14000 1992 até 1998 modelo Sapão
F-4000 1992 até 1998 modelo Sapão



MANUAL

Máquina levanta cristal - 2 puertas/4 puertas - delantero



R-5226D
O&M: XC3Z2523200AA
R-5226E
O&M: XC3Z2523201AA

F-12000 1999 até 2006 Pit Bull
F-14000 1999 até 2016 Pit Bull
F-16000 1999 até 2016 Pit Bull
F-250 1998 até 2012
F-350 1999 até 2010
F-4000 1998 até 2012



FORD

MANUAL

Máquina levanta cristal - 4 puertas - trasero



R-5247D
O&M: 8C3Z2627000A
R-5247E
O&M: 8C3Z2627001A

F-250 1998 até 2012
F-350 1999 até 2010
F-4000 1998 até 2012

ELECTRICA - S/MOTOR - motor inverso

Máquina levanta cristal - 2 puertas - Mabuchi (8 dientes)



R-5222D SM
O&M: 89TU81234W00B SM
R-5222E SM
O&M: 89TU81234W01B SM

F-1000 1979 até 1991
F-4000 1985 até 1991
F-600 1972 até 1979



ELECTRICA - S/MOTOR - motor inverso

Máquina levanta cristal - 2 puertas - Mabuchi (8 dientes)



R-5229D SM
O&M: 2SA837502A SM
R-5229E SM
O&M: 2SA837501A SM

F-1000 1992 até 1998 modelo Sapão
F-12000 1992 até 1998 modelo Sapão
F-14000 1992 até 1998 modelo Sapão
F-4000 1992 até 1998 modelo Sapão



ELECTRICA - S/MOTOR

Máquina levanta cristal - 2 puertas/4 puertas - delantero - Mabuchi (8 dientes)



R-5235D SM
O&M: XC3Z2523200BA SM
R-5235E SM
O&M: XC3Z2523201BA SM

F-12000 1999 até 2006 Pit Bull
F-14000 1999 até 2016 Pit Bull
F-16000 1999 até 2016 Pit Bull
F-250 1998 até 2012
F-350 1999 até 2010
F-4000 1998 até 2012



ELECTRICA - S/MOTOR

Máquina levanta cristal - 4 puertas - trasero - Mabuchi (8 dientes)



R-5248D SM
O&M: 8C3Z2627000B SM
R-5248E SM
O&M: 8C3Z2627001B SM

F-250 1998 até 2012
F-350 1999 até 2010
F-4000 1998 até 2012

MANUAL

Máquina levanta cristal - 2 puertas



R-5148D
O&M: 81DBE23200AJ / 9C457023200AA
R-5148E
O&M: 81DBE23201AH / 9C457023201AA

Cargo 1981 até 2012



ELECTRICA - S/MOTOR

Máquina levanta cristal - 2 puertas - Mabuchi (8 dientes)



R-5233D SM
O&M: 81DBE23200AJ SM
R-5233E SM
O&M: 81DBE23201AJ SM

Cargo 1981 até 2013

ELECTRICA - S/MOTOR

Máquina levanta cristal - 2 puertas - Mabuchi (8 dientes)

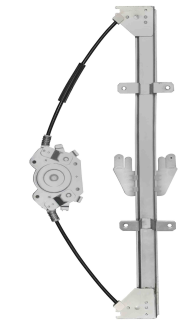

R-5249D SM
O&M: 3C46E23200BE SM
R-5249E SM
O&M: 3C46E23201BE SM

Cargo 2011 em diante



ELECTRICA - S/MOTOR

Máquina levanta cristal - 2 puertas - Bosch (32 estrías)



R-5237D SM
O&M: 3C46E23200BE SM
R-5237E SM
O&M: 3C46E23201BE SM

Cargo 2011 em diante



ELECTRICA - S/MOTOR

Máquina levanta cristal - 2 puertas - original (32 estrías)



R-5252D SM
O&M: EC457023200BB
R-5252E SM
O&M: EC457023201BB

Cargo C-816 / C-1119 2013 em diante



ELECTRICA - S/MOTOR

Máquina levanta cristal - 2 puertas - delantero - Mabuchi (8 dientes)

R-7535D SM
O&M: 815025h100 SM
R-7535E SM
O&M: 815015h100 SM

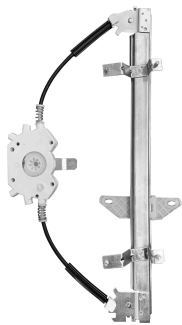

HD80 2019 em diante

MANUAL

Máquina levanta cristal - 2 puertas

R-1424D
O&M: 2997185
R-1424E
O&M: 2997186



Cavallino 320 1998 em diante
Eurocargo 1998 em diante
Stralis 1998 em diante
Tector 1998 em diante



MANUAL

Máquina levanta cristal - 2 puertas

R-1501D
O&M: 5949891222
R-1501E
O&M: 5949891263



Vertis 2011 em diante



ELECTRICA - S/MOTOR

Máquina levanta cristal - 2 puertas - Mabuchi (8 dientes)

R-1445D SM
O&M: 2997195RH SM
R-1445E SM
O&M: 2997196LH SM



Cavallino 320 1998 em diante
Eurocargo 1998 em diante
Stralis 1998 em diante
Tector 1998 em diante



ELECTRICA - S/MOTOR

Máquina levanta cristal - original (32 estrías)

R-1453D SM
O&M: 504040988
R-1453E SM
O&M: 504040989



Cavallino 320 1998 em diante
Eurocargo 1998 em diante
Stralis 1998 em diante
Tector 1998 em diante



ELECTRICA - S/MOTOR

Máquina levanta cristal - 2 puertas - Mabuchi (8 dientes)

R-1446D SM
O&M: 5949891164 SM
R-1446E SM
O&M: 5949891165 SM



Vertis 2011 em diante



Cerradura de puerta



F-2300D
O&M: A3087207135
F-2300E
O&M: A3087207035

608 1983 até 1990

Cerradura de puerta



F-2301D
O&M: A3447207135
F-2301E
O&M: A3447207035

1111 / 1113 / 1313 / 1513 / 2013 / 2213 até 1990

Cerradura de puerta - interna



F-2303D
O&M: 6887207135
F-2303E
O&M: 6887207035

709 até 1996

Cierre del capot - inferior



F-2302I
O&M: 3328800060

1111 / 1113 / 1313 / 1513 / 2013 / 2213 até 1990

Cierre del capot - superior



F-2302S
O&M: 3328800160

1111 / 1113 / 1313 / 1513 / 2013 / 2213 até 1990

Cierre del capot - inferior

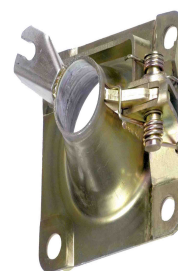

F-2309I
O&M: A3848807660INF

1214 / 1618 / HPN até 2000

Cierre del capot - superior



F-2309S
O&M: A3848807660SUP

1214 / 1618 / HPN até 2000

Cierre del capot - inferior



F-2306I
O&M: A6948800260INF

1418 / 1620 / HPN 2001 em diante

Cierre del capot - superior



F-2306S
O&M: A6948800160SUP

1418 / 1620 / HPN 2001 em diante

MANUAL

Máquina levanta cristal - 2 puertas - pin bajo



R-2121D
O&M: 3447680101
R-2121E
O&M: 3447680001

1111 / 1113 / 1313 / 1513 / 2013 / 2213
1973 até 1982



MANUAL

Máquina levanta cristal - 2 puertas - pin alto



R-2122D
O&M: 3317257202
R-2122E
O&M: 3317257302

1111 / 1113 / 1313 / 1513 / 2013 / 2213
1983 até 1990



MANUAL

Máquina levanta cristal - 2 puertas



R-2125D
O&M: A3086707303
R-2125E
O&M: A3086707203

608 1983 até 1990



MANUAL

Máquina levanta cristal - 2 puertas - pin alto - exportación

R-2124D
O&M: 3817250102
R-2124E
O&M: 3817250002



Zetros / Unimog

MANUAL

Máquina levanta cristal - 2 puertas - pin alto

R-2123D
O&M: 6887207146
R-2123E
O&M: 6887207046



507 / 809 / 811 / 909 / 1938 1991
até 2000



MANUAL

Máquina levanta cristal - 2 puertas

R-2120D
O&M: 6887207646
R-2120E
O&M: 6887207546



1935 / 1938 / 1218 / 1418 2001 em
diante
709 2001 em diante



MANUAL

Máquina levanta cristal - 2 puertas - pin bajo

R-2307D
O&M: 9737200246
R-2307E
O&M: 9737200146



1938S 2006 em diante
Atego 2006 em diante
Axor 2006 em diante



MANUAL

Máquina levanta cristal - 2 puertas - pin alto

R-2314D
O&M: 9737200246
R-2314E
O&M: 9737200146



1938S 2006 em diante
Atego 2006 em diante
Axor 2006 em diante



MANUAL

Máquina levanta cristal - 2 puertas - delantero

R-2316D
O&M: A9797207046
R-2316E
O&M: A9797207146



Acello 715 / 915 2002 até 2011



MANUAL

Máquina levanta cristal - 2 puertas

R-2308D
O&M: 9797201246
R-2308E
O&M: 9797201146



Acello 1016 2012 em diante
Acello 815 2012 em diante



MANUAL

Máquina levanta cristal - exportación

R-2305D
R-2305E



MB Alemão

ELECTRICA - S/MOTOR

Máquina levanta cristal - 2 puertas - Bosch (10 dientes)

R-2310D SM
O&M: 7200446 SM
R-2310E SM
O&M: 9797200346 SM



1938S 2006 em diante
Atego 2006 em diante
Axor 2006 em diante



ELECTRICA - S/MOTOR - motor inverso

Máquina levanta cristal - 2 puertas - Mabuchi (8 dientes)

R-2312D SM
O&M: 9797200446 SM
R-2312E SM
O&M: 9797200346 SM



1938S 2006 em diante
Atego 2006 em diante
Axor 2006 em diante



ELECTRICA - S/MOTOR

Máquina levanta cristal - Brose (32 estrías)

R-2315D SM
O&M: 9797200446
R-2315E SM
O&M: 9797200346



1938S 2006 em diante
Atego 2006 em diante
Axor 2006 em diante



ELECTRICA - S/MOTOR - motor inverso

Máquina levanta cristal - 2 puertas - Mabuchi (8 dientes)

R-2126D SM
O&M: A3847207146 SM
R-2126E SM
O&M: A3847207046 SM



HPN 709 / 1935 1991 até 2000



ELECTRICA - S/MOTOR - motor inverso

Máquina levanta cristal - 2 puertas - Mabuchi (8 dientes)



R-2128D SM
O&M: 6967200146 SM
R-2128E SM
O&M: 6967200246 SM

Atron 2001 em diante
HPN 709 / 1935 2001 em diante



ELECTRICA - S/MOTOR

Máquina levanta cristal - 2 puertas - Mabuchi (8 dientes)



R-2129D SM
O&M: 3317257202 SM
R-2129E SM
O&M: 3317257302 SM

1111 / 1113 / 1313 / 1513 / 2013 / 2213
até 1990



ELECTRICA - S/MOTOR - motor inverso

Máquina levanta cristal - 2 puertas - Mabuchi (8 dientes)



R-2311D SM
O&M: 9797200246 SM
R-2311E SM
O&M: 9797200146 SM

Acello 715 / 915 2002 até 2011
Acello 915 2002 até 2011



ELECTRICA - S/MOTOR - motor inverso

Máquina levanta cristal - 2 puertas - Mabuchi (8 dientes)



R-2313D SM
O&M: 9797200946 SM
R-2313E SM
O&M: 9797200846 SM

Acello 1016 2012 em diante
Acello 815 2012 em diante



MANUAL

Máquina levanta cristal - 2 puertas - con ventilete



R-2601D
O&M: 66736
R-2601E
O&M: 66735

L75 / L76 1970 até 1974

MANUAL

Máquina levanta cristal - 2 puertas - sin ventilete

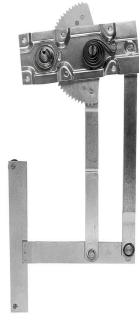

R-2602D
O&M: 236256
R-2602E
O&M: 236255

L110 / L111 1975 até 1980

MANUAL

Máquina levanta cristal - 2 puertas



R-2603D
O&M: 296430
R-2603E
O&M: 296429

T / R 112 1981 até 1987



MANUAL

Máquina levanta cristal - 2 puertas



R-2604D
O&M: 524784
R-2604E
O&M: 524783

T / R 113 1988 até 1997



MANUAL

Máquina levanta cristal - 2 puertas



R-2605D
O&M: 187720
R-2605E
O&M: 187719

LK140 / LK141 1988 em diante

MANUAL

Máquina levanta cristal - 2 puertas



R-2606D
O&M: 1366848
R-2606E
O&M: 1366847

Série 4 / 5 / 6 T-R-P-G 1998 em diante



ELECTRICA - S/MOTOR

Máquina levanta cristal - 2 puertas - original (10 dientes)



R-2608D SM
O&M: 376674 SM
R-2608E SM
O&M: 376673 SM

Série 3 R112 / R113 / T112 / T113 1981 até 1997



ELECTRICA - S/MOTOR

Máquina levanta cristal - 2 puertas - Bosch (10 dientes)



R-2607D SM
O&M: 1442294 SM
R-2607E SM
O&M: 1442295 SM

Série 4 / 5 / 6 T-R-P-G 1998 em diante



VOLVO

Cerradura de puerta



F-2915D
O&M: 8123612
F-2915E
O&M: 8123611

NL10 / NL12 / EDC 1992 até 1999

MANUAL

Máquina levanta cristal - 2 puertas



R-2610D
O&M: 6889224
R-2610E
O&M: 6889223

N / NL cabina corta 1983 até 1989

MANUAL

Máquina levanta cristal - 2 puertas



R-2611D
O&M: 8123658
R-2611E
O&M: 8123657

NL10 / NL12 / EDC cabina larga 1992 até 1999



MANUAL

Máquina levanta cristal - 2 puertas



R-2612D
O&M: 8123248
R-2612E
O&M: 8123247

NL10 / NL12 cabina normal 1990 até 1994

MANUAL

Máquina levanta cristal - 2 puertas



R-2617D
O&M: 3176542
R-2617E
O&M: 3176541

FM / FH12 / FH13 1994 em diante



MANUAL

Máquina levanta cristal - 2 puertas



R-2616D
O&M: 20557550
R-2616E
O&M: 20557548

VM 2004 em diante



ELECTRICA - S/MOTOR

Máquina levanta cristal - 2 puertas - Mabuchi (8 dientes)



R-2613D SM
O&M: 8123550 SM
R-2613E SM
O&M: 8123551 SM

NL10 / NL12 / EDC cabina larga 1992 até 1999



ELECTRICA - S/MOTOR

Máquina levanta cristal - 2 puertas - original (10 dientes)



R-2615D SM
O&M: 3176546 SM
R-2615E SM
O&M: 3176545 SM

FM / FH12 / FH13 1994 em diante



ELECTRICA - S/MOTOR

Máquina levanta cristal - 2 puertas - original (cuadrado)



R-2618D SM
O&M: 20557554 SM
R-2618E SM
O&M: 20557552 SM

VM 2004 em diante



ELECTRICA - S/MOTOR

Máquina levanta cristal - 2 puertas - Mabuchi (8 dientes)

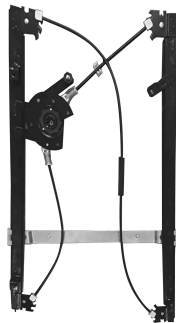

R-2614D SM
O&M: 20557554 SM
R-2614E SM
O&M: 20557552 SM

VM 2004 em diante



VOLVO

MANUAL

Máquina levanta cristal

R-7701D
R-7701E



13000 2007 até 2012
8500 2007 até 2012
9200 2004 até 2012
Buses Agrale 2004 em diante

MANUAL

Máquina levanta cristal - 2 puertas - delantero

R-7703D
R-7703E



Agrale GIII 8700 / 10000 / 14000 2012 em diante

ELECTRICA - S/MOTOR - motor inverso

Máquina levanta cristal - 2 puertas - delantero - Mabuchi (8 dientes)

R-7705D SM
O&M: 6023011052004
R-7705E SM
O&M: 6023011053002



Agrale GIII 8700/1400 2012 em diante

MARCOPOLO

Cerradura de puerta

F-2655D
O&M: 27242687
F-2655E
O&M: 27242686

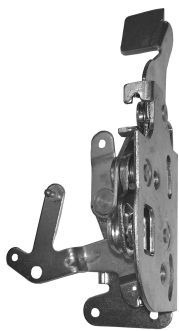

G6 1996 até 2009

MANUAL
Máquina levanta cristal

R-2656D
R-2656E



versão nova

MANUAL
Máquina levanta cristal

R-2657D
R-2657E



2122

MANUAL
Máquina levanta cristal

R-2658D
R-2658E



2603

MARCOPOLO

MANUAL

Máquina levanta cristal - 2 puertas - pin cuadrado

R-2599E
O&M: 218000569



RK424 / RK424B

MANUAL

Máquina levanta cristal - 2 puertas - pin estriado

R-2600D
R-2600E
O&M: 21800206



RK424 / RK424B

ELECTRICA - S/MOTOR

Máquina levanta
cristal - 2 puertas -
delantero -
Mabuchi (8 dientes)

R-2703D SM
O&M: 6EA839462
R-2703E SM
O&M: 6EA839461

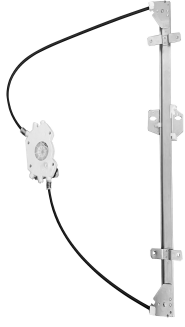

Daf CF85 2003 até 2021



Est. Água Chata, 1233, Bonsucesso
Guarulhos, SP - CEP 07251-000
(11) 2088-7200