

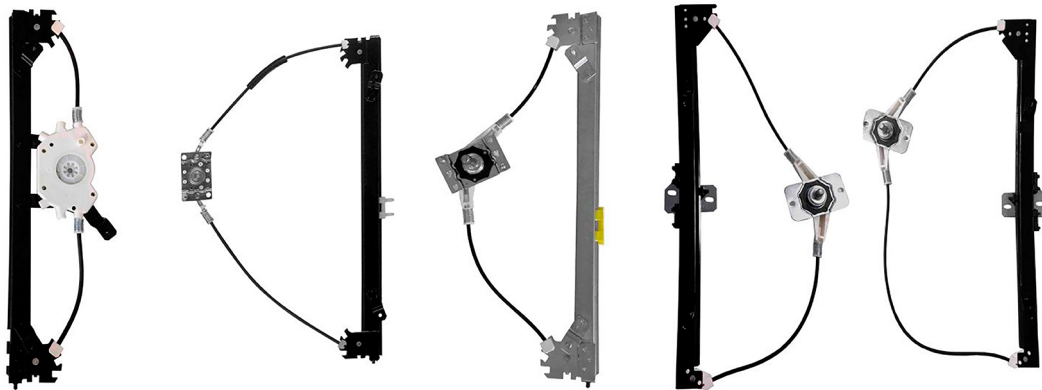

Zinni & Güell

Indústria de Auto Peças Ltda.



LINEA PESADA

SIN MÁQUINAS LEVANTA CRISTAL Y MOTORES



Canal de YouTube - pionero con consejos e instalaciones de productos

● GM	1
● VOLKSWAGEN	1
● FORD	1
● MERCEDES-BENZ	2
● VOLVO	3
● MARCOPOLO	3

Bisagra tapa
delantera - con
resorte

D-3383D
O&M: 7362032
D-3383E
O&M: 7362031



A-10 até 1984
C-10 até 1984
D-10 até 1984

Bisagra tapa
delantera - con
resorte

D-3384D
O&M: 94630704
D-3384E
O&M: 94630703



C-20 1985 em diante
D-20 1985 em diante
D-40 1985 em diante

Bisagra tapa
delantera - soporte

S-3385



A-10 até 1984
C-10 até 1984
D-10 até 1984

Cerradura de puerta -
delantero

F-4498D
O&M: 2318370161
F-4498E
O&M: 2318370151



Kombi Clipper 1976 até 1996
Worker / Titan / Tractor 1980 em diante

Bisagra tapa
delantera - con
resorte

D-5240D
O&M: 90TU16900BA
D-5240E
O&M: 90TU16801BA



F-11000 até 1991
F-13000 até 1989
F-600 até 1991

Bisagra tapa
delantera

D-5241D
O&M: T75823306A
D-5241E
O&M: T75823305A



F-12000 1993 até 1998 modelo Sapão
F-12000 L 1993 até 1998 modelo Sapão
F-14000 HD 1993 até 1998 modelo Sapão

Bisagra tapa
delantera - con
resorte

D-5238D
O&M: 90TU16800A
D-5238E
O&M: 90TU16801A



F-1000 até 1992
F-4000 até 1992

Bisagra tapa
delantera - con
resorte

D-5239D
O&M: TNK823335
D-5239E
O&M: EITQ16796A



F-1000 1992 até 1998
F-4000 1992 até 1998

Cierre del capot -
inferior

F-5242I
O&M: 89TU16900AA

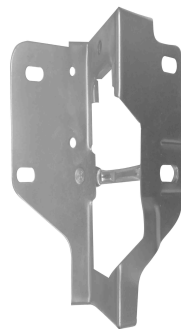

F-1000 até 1989
F-4000 até 1989

Cierre del capot -
superior - sin cable

F-5242S
O&M: DOTB16700B

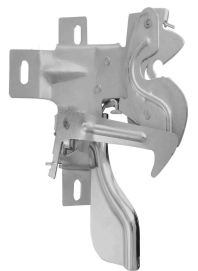

F-1000 até 1989
F-11000 até 1989
F-14000 até 1989
F-4000 até 1989
F-7000 até 1989

GM

VOLKSWAGEN

FORD

FORD

FORD

Cierre del capot - superior - con cable

F-5243S
O&M: 89TU16700AA

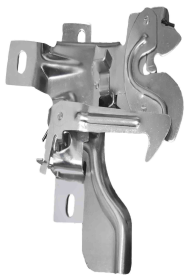

F-1000 1989 até 1992
F-11000 1989 até 1992
F-14000 1989 até 1992
F-4000 1989 até 1992
F-7000 1989 até 1992

Cierre del capot - inferior

F-5244I
O&M: C7TZ16892B



F-11000
F-600

MERCEDES-BENZ

Cerradura de puerta

F-2300D
O&M: A3087207135
F-2300E
O&M: A3087207035

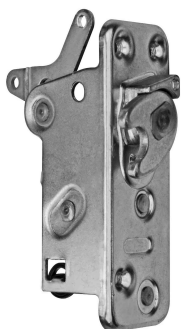

608 1983 até 1990

Cerradura de puerta

F-2301D
O&M: A3447207135
F-2301E
O&M: A3447207035



1111 / 1113 / 1313 / 1513 / 2013 / 2213 até 1990

Cerradura de puerta - interna

F-2303D
O&M: 6887207135
F-2303E
O&M: 6887207035



709 até 1996

MERCEDES-BENZ

Cierre del capot - inferior

F-2302I
O&M: 3328800060



1111 / 1113 / 1313 / 1513 / 2013 / 2213 até 1990

Cierre del capot - superior

F-2302S
O&M: 3328800160



1111 / 1113 / 1313 / 1513 / 2013 / 2213 até 1990

Cierre del capot - inferior

F-2309I
O&M: A3848807660INF

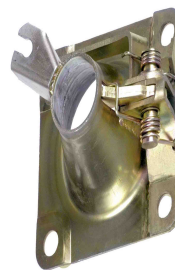

1214 / 1618 / HPN até 2000

MERCEDES-BENZ

Cierre del capot - superior

F-2309S
O&M: A3848807660SUP



1214 / 1618 / HPN até 2000

Cierre del capot - inferior

F-2306I
O&M: A6948800260INF



1418 / 1620 / HPN 2001 em diante

Cierre del capot - superior

F-2306S
O&M: A6948800160SUP



1418 / 1620 / HPN 2001 em diante

Cerradura de puerta



F-2915D
O&M: 8123612
F-2915E
O&M: 8123611

NL10 / NL12 / EDC 1992 até 1999

Cerradura de puerta

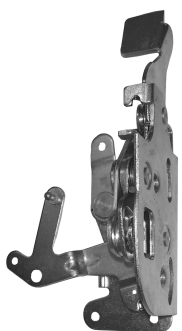

F-2655D
O&M: 27242687
F-2655E
O&M: 27242686

G6 1996 até 2009



Est. Água Chata, 1233, Bonsucesso
Guarulhos, SP - CEP 07251-000
(11) 2088-7200