

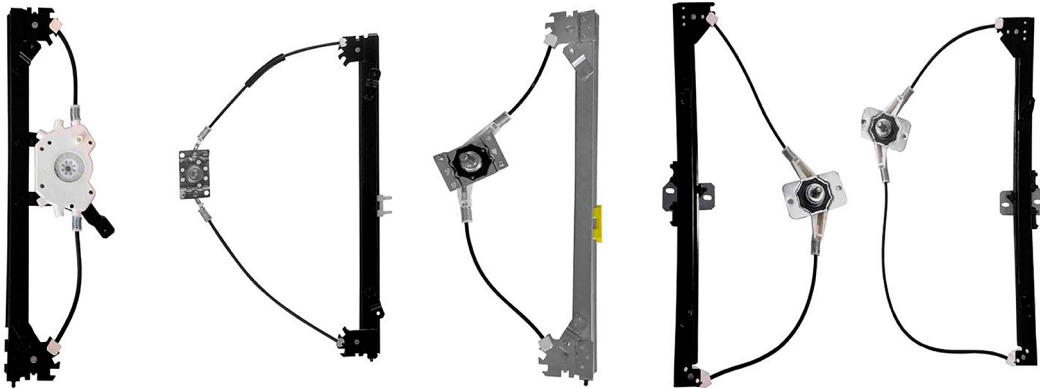

**Zinni & Güell**

**Indústria de Auto Peças Ltda.**



**LINEA PICK-UP**



Canal de YouTube - pionero con consejos e instalaciones de productos

● GM	1
● VOLKSWAGEN	3
● FORD	4
● TOYOTA	7
● MITSUBISHI	8
● NISSAN	9
● AGRALE	10

Bisagra tapa  
delantera - con  
resorte

D-3383D  
O&M: 7362032  
D-3383E  
O&M: 7362031



A-10 até 1984  
C-10 até 1984  
D-10 até 1984

Bisagra tapa  
delantera - con  
resorte

D-3384D  
O&M: 94630704  
D-3384E  
O&M: 94630703



C-20 1985 em diante  
D-20 1985 em diante  
D-40 1985 em diante

Bisagra tapa  
delantera - soporte

S-3385



A-10 até 1984  
C-10 até 1984  
D-10 até 1984

**MANUAL**

Máquina levanta  
cristal - 2 puertas -  
delantero

R-3114D  
O&M: 7320092  
R-3114E  
O&M: 7320091



C-10 1972 até 1985  
D-10 1979 até 1985  
D-60 1965 até 1985  
Veraneio 1971 até 1985



**MANUAL**

Máquina levanta  
cristal - 2 puertas

R-3116D  
O&M: 94637552  
R-3116E  
O&M: 94637551



A-20 1985 até 1990  
A-40 1985 até 1990  
C-20 1985 até 1990  
D-20 1985 até 1990  
D-40 1985 até 1990



**MANUAL**

Máquina levanta  
cristal -  
2 puertas/4 puertas -  
delantero

R-3346D  
O&M: 52255122  
R-3346E  
O&M: 52255121



A-20 1991 até 1996  
A-40 1991 até 1996  
Bonanza 1991 até 1994  
C-20 1991 até 1996  
D-12000 1991 até 1996  
D-20 1991 até 1996  
D-40 1991 até 1996  
Veraneio 1991 até 1994



**MANUAL**

Máquina levanta  
cristal - 4 puertas -  
trasero

R-3347D  
O&M: 52255126  
R-3347E  
O&M: 52255125



A-20 1991 até 1996  
A-40 1991 até 1996  
Bonanza 1991 até 1994  
C-20 1991 até 1996  
D-12000 1991 até 1996  
D-20 1991 até 1996  
D-40 1991 até 1996  
Veraneio 1991 até 1994



**MANUAL**

Máquina levanta  
cristal -  
2 puertas/4 puertas -  
delantero

R-3345D  
O&M: 15705142  
R-3345E  
O&M: 15705141



Blazer 1995 até 2011  
S10 1995 até 2011



**ELECTRICA - S/MOTOR - motor inverso**

Máquina levanta  
cristal - 4 puertas -  
delantero -  
Mabuchi (8 dientes)

R-3332D SM  
O&M: 52255124 SM  
R-3332E SM  
O&M: 52255123 SM



A-20 1991 até 1996  
Bonanza 1991 até 1994  
C-20 1991 até 1996  
D-20 1991 até 1996  
Veraneio 1991 até 1994



**ELECTRICA - S/MOTOR**

Máquina levanta  
cristal - 4 puertas -  
trasero -  
Mabuchi (8 dientes)

R-3333D SM  
O&M: 52255128 SM  
R-3333E SM  
O&M: 52255127 SM

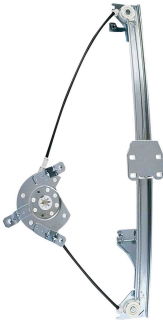

A-20 1991 até 1996  
Bonanza 1991 até 1994  
C-20 1991 até 1996  
D-20 1991 até 1996  
Veraneio 1991 até 1994



**ELECTRICA - S/MOTOR - motor inverso**

Máquina levanta  
cristal -  
2 puertas/4 puertas -  
delantero -  
Mabuchi (8 dientes)

R-3344D SM  
O&M: 15705144 SM  
R-3344E SM  
O&M: 15705143 SM



Blazer 1995 até 2011  
S10 1995 até 2011



**ELECTRICA - S/MOTOR**

Máquina levanta  
cristal -  
2 puertas/4 puertas -  
delantero -  
Mabuchi (8 dientes)

R-3357D SM  
O&M: 947736650 SM  
R-3357E SM  
O&M: 947736649 SM



S10 2012 em diante

**ELECTRICA - S/MOTOR - motor inverso**

Máquina levanta cristal - 4 puertas - trasero - Mabuchi (8 dientes)

R-3358D SM  
O&M: 5483149 SM  
R-3358E SM  
O&M: 5483148 SM



S10 2012 em diante

**ELECTRICA - S/MOTOR - motor inverso**

Máquina levanta cristal - 4 puertas - trasero - Mabuchi (8 dientes) - el cristal baja hasta el final del curso

R-3363D SM  
O&M: 5483149 SM  
R-3363E SM  
O&M: 5483148 SM



S10 2012 em diante

**ELECTRICA - C/MOTOR - motor inverso**

Máquina levanta cristal - 4 puertas - delantero - Mabuchi (8 dientes)

R-3332D  
O&M: 52255124  
R-3332E  
O&M: 52255123



A-20 1991 até 1996  
Bonanza 1991 até 1994  
C-20 1991 até 1996  
D-20 1991 até 1996  
Veraneio 1991 até 1994

**ELECTRICA - C/MOTOR**

Máquina levanta cristal - 4 puertas - trasero - Mabuchi (8 dientes)

R-3333D  
O&M: 52255128  
R-3333E  
O&M: 52255127



A-20 1991 até 1996  
Bonanza 1991 até 1994  
C-20 1991 até 1996  
D-20 1991 até 1996  
Veraneio 1991 até 1994

**ELECTRICA - C/MOTOR - motor inverso**

Máquina levanta cristal - 2 puertas/4 puertas - delantero - Mabuchi (8 dientes)

R-3344D  
O&M: 15705144  
R-3344E  
O&M: 15705143



Blazer 1995 até 2011  
S10 1995 até 2011

**ELECTRICA - C/MOTOR**

Máquina levanta cristal - 2 puertas/4 puertas - delantero - Mabuchi (8 dientes)

R-3357D  
O&M: 947736650  
R-3357E  
O&M: 947736649



S10 2012 em diante

**ELECTRICA - C/MOTOR - motor inverso**

Máquina levanta cristal - 4 puertas - trasero - Mabuchi (8 dientes)

R-3358D  
O&M: 5483149  
R-3358E  
O&M: 5483148



S10 2012 em diante

**ELECTRICA - C/MOTOR - motor inverso**

Máquina levanta cristal - 4 puertas - trasero - Mabuchi (8 dientes) - el cristal baja hasta el final del curso

R-3363D  
O&M: 5483149  
R-3363E  
O&M: 5483148



S10 2012 em diante

**ELECTRICA - S/MOTOR**

Máquina levanta cristal - delantero - original

R-4143D SM  
O&M: 2H0837402H  
R-4143E SM  
O&M: 2H0837401L



Amarok 2010 em diante

Reparación máquina levanta cristal eléctricos - 2 puertas - delantero - sin motor - Mabuchi (8 dientes)

R-4178D SM  
O&M: IJ3837462 SM  
R-4178E SM  
O&M: IJ3837461 SM



Amarok 2010 em diante  
Golf 1999 até 2014  
Polo 2002 até 2014

Reparación máquina levanta cristal eléctricos - 2 puertas - delantero - con motor - Mabuchi (8 dientes)

R-4178D  
O&M: IJ3837462  
R-4178E  
O&M: IJ3837461



Amarok 2010 em diante  
Golf 1999 até 2014  
Polo 2002 até 2014

Bisagra tapa  
delantera - con  
resorte

D-5238D  
O&M: 90TU16800A  
D-5238E  
O&M: 90TU16801A



F-1000 até 1992  
F-4000 até 1992

Bisagra tapa  
delantera - con  
resorte

D-5239D  
O&M: TNK823335  
D-5239E  
O&M: EITQ16796A



F-1000 1992 até 1998  
F-4000 1992 até 1998

Cierre del capot -  
inferior

F-5242I  
O&M: 89TU16900AA

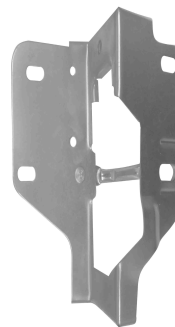

F-1000 até 1989  
F-4000 até 1989

Cierre del capot -  
superior - sin cable

F-5242S  
O&M: DOTB16700B

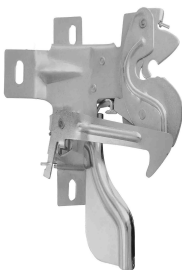

F-1000 até 1989  
F-11000 até 1989  
F-14000 até 1989  
F-4000 até 1989  
F-7000 até 1989

Cierre del capot -  
superior - con cable

F-5243S  
O&M: 89TU16700AA

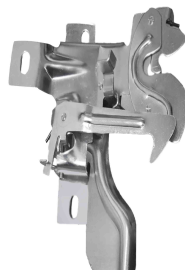

F-1000 1989 até 1992  
F-11000 1989 até 1992  
F-14000 1989 até 1992  
F-4000 1989 até 1992  
F-7000 1989 até 1992

#### MANUAL

Máquina levanta  
cristal - 2 puertas

R-5223D  
O&M: BD3B98231WOO  
R-5223E  
O&M: BD3B98231WOI

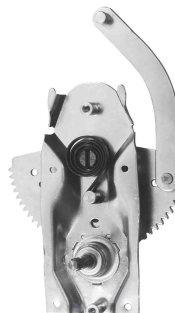

F-75 1970 até 1982  
Rural Willys 1956 até 1977

#### MANUAL

Máquina levanta  
cristal - 2 puertas

R-5141D  
O&M: BD3C8123200A  
R-5141E  
O&M: BD3C8123201A



F-100 1972 até 1986  
F-1000 1979 até 1991  
F-11000 1981 até 1991  
F-4000 1985 até 1991



#### MANUAL

Máquina levanta  
cristal - 2 puertas

R-5149D  
O&M: T71837502D  
R-5149E  
O&M: T71837501D



F-1000 1992 até 1998 modelo  
Sapão  
F-12000 1992 até 1998 modelo  
Sapão  
F-14000 1992 até 1998 modelo  
Sapão  
F-4000 1992 até 1998 modelo  
Sapão



#### MANUAL

Máquina levanta  
cristal -  
2 puertas/4 puertas -  
delantero

R-5226D  
O&M: XC3Z2523200AA  
R-5226E  
O&M: XC3Z2523201AA



F-12000 1999 até 2006 Pit Bull  
F-14000 1999 até 2016 Pit Bull  
F-16000 1999 até 2016 Pit Bull  
F-250 1998 até 2012  
F-350 1999 até 2010  
F-4000 1998 até 2012



#### MANUAL

Máquina levanta  
cristal - 4 puertas -  
trasero

R-5247D  
O&M: 8C3Z2627000A  
R-5247E  
O&M: 8C3Z2627001A



F-250 1998 até 2012  
F-350 1999 até 2010  
F-4000 1998 até 2012



#### MANUAL

Máquina levanta  
cristal -  
2 puertas/4 puertas -  
delantero

R-5146D  
O&M: F37Z1023200A  
R-5146E  
O&M: F37Z1023201A



Ranger 1994 até 2011



#### MANUAL

Máquina levanta  
cristal - 4 puertas -  
trasero

R-5154D  
O&M: YL543527000AA  
R-5154E  
O&M: YL543527001AA



Ranger 1998 até 2011



**ELECTRICA - S/MOTOR - motor inverso**

Máquina levanta cristal - 2 puertas - Mabuchi (8 dientes)



R-5222D SM  
O&M: 89TU81234W00B SM  
R-5222E SM  
O&M: 89TU81234W01B SM

F-1000 1979 até 1991  
F-4000 1985 até 1991  
F-600 1972 até 1979



**ELECTRICA - S/MOTOR - motor inverso**

Máquina levanta cristal - 2 puertas - Mabuchi (8 dientes)



R-5229D SM  
O&M: 2SA837502A SM  
R-5229E SM  
O&M: 2SA837501A SM

F-1000 1992 até 1998 modelo Sapão  
F-12000 1992 até 1998 modelo Sapão  
F-14000 1992 até 1998 modelo Sapão  
F-4000 1992 até 1998 modelo Sapão



**ELECTRICA - S/MOTOR**

Máquina levanta cristal - 2 puertas/4 puertas - delantero - Mabuchi (8 dientes)



R-5235D SM  
O&M: XC3Z2523200BA SM  
R-5235E SM  
O&M: XC3Z2523201BA SM

F-12000 1999 até 2006 Pit Bull  
F-14000 1999 até 2016 Pit Bull  
F-16000 1999 até 2016 Pit Bull  
F-250 1998 até 2012  
F-350 1999 até 2010  
F-4000 1998 até 2012



**ELECTRICA - S/MOTOR**

Máquina levanta cristal - trasero - Mabuchi (8 dientes)



R-5248D SM  
O&M: 8C3Z2627000B SM  
R-5248E SM  
O&M: 8C3Z2627001B SM

F-250 1998 até 2012  
F-350 1999 até 2010  
F-4000 1998 até 2012

**ELECTRICA - S/MOTOR - motor inverso**

Máquina levanta cristal - 2 puertas/4 puertas - delantero - Mabuchi (8 dientes)



R-5147D SM  
O&M: F57Z/1023208/AA SM  
R-5147E SM  
O&M: F57Z/1023209/AA SM

Ranger 1994 até 2011



**ELECTRICA - S/MOTOR**

Máquina levanta cristal - 4 puertas - trasero - Mabuchi (8 dientes)



R-5153D SM  
O&M: 7L553527000AA SM  
R-5153E SM  
O&M: 7L553527001AA SM

Ranger 1998 até 2011



**ELECTRICA - S/MOTOR**

Máquina levanta cristal - 2 puertas/4 puertas - delantero - Mabuchi (8 dientes)



R-5227D SM  
O&M: AB392123200BC SM  
R-5227E SM  
O&M: AB392123201BC SM

Ranger 2012 em diante



**ELECTRICA - S/MOTOR**

Máquina levanta cristal - 4 puertas - delantero - original (34 estrias)



R-5253D SM  
O&M: AB392123200  
R-5253E SM  
O&M: AB392123201

Ranger 2012 em diante



**ELECTRICA - S/MOTOR**

Máquina levanta cristal - 4 puertas - trasero - Mabuchi (8 dientes)



R-5228D SM  
O&M: AB392627000BC SM  
R-5228E SM  
O&M: AB392627001BC SM

Ranger 2012 em diante



**ELECTRICA - S/MOTOR**

Máquina levanta cristal - 4 puertas - trasero - original (32 estrias)



R-5157D SM  
O&M: AB392627000BC/CCS SM  
R-5157E SM  
O&M: AB392627001BC/CCS SM

Ranger 2012 em diante



**ELECTRICA - C/MOTOR - motor inverso**

Máquina levanta cristal - 2 puertas - Mabuchi (8 dientes)



R-5222D  
O&M: 89TU81234W00B  
R-5222E  
O&M: 89TU81234W01B

F-1000 1979 até 1991  
F-4000 1985 até 1991  
F-600 1972 até 1979



**ELECTRICA - C/MOTOR - motor inverso**

Máquina levanta cristal - 2 puertas - Mabuchi (8 dientes)



R-5229D  
O&M: 2SA837502A  
R-5229E  
O&M: 2SA837501A

F-1000 1992 até 1998 modelo Sapão  
F-12000 1992 até 1998 modelo Sapão  
F-14000 1992 até 1998 modelo Sapão  
F-4000 1992 até 1998 modelo Sapão



**ELECTRICA - C/MOTOR**

Máquina levanta cristal -  
2 puertas/4 puertas -  
delantero -  
Mabuchi (8 dientes)



R-5235D 12V  
O&M: XC3Z2523200BA  
R-5235E 12V  
O&M: XC3Z2523201BA

F-12000 1999 até 2006 Pit Bull  
F-14000 1999 até 2016 Pit Bull  
F-16000 1999 até 2016 Pit Bull  
F-250 1998 até 2012  
F-350 1999 até 2010  
F-4000 1998 até 2012

**ELECTRICA - C/MOTOR - motor inverso**

Máquina levanta cristal - 4 puertas -  
trasero -  
Mabuchi (8 dientes)



R-5248D 12V  
O&M: 8C3Z2627000B  
R-5248E 12V  
O&M: 8C3Z2627001B

F-250 1998 até 2012  
F-350 1999 até 2010  
F-4000 1998 até 2012

**ELECTRICA - C/MOTOR - motor inverso**

Máquina levanta cristal -  
2 puertas/4 puertas -  
delantero -  
Mabuchi (8 dientes)



R-5147D  
O&M: F57Z/1023208/AA  
R-5147E  
O&M: F57Z/1023209/AA

Ranger 1994 até 2011

**ELECTRICA - C/MOTOR**

Máquina levanta cristal - 4 puertas -  
trasero -  
Mabuchi (8 dientes)



R-5153D  
O&M: 7L553527000AA  
R-5153E  
O&M: 7L553527001AA

Ranger 1998 até 2011

**ELECTRICA - C/MOTOR**

Máquina levanta cristal -  
2 puertas/4 puertas -  
delantero -  
Mabuchi (8 dientes)



R-5227D  
O&M: AB392123200BC  
R-5227E  
O&M: AB392123201BC

Ranger 2012 em diante

**ELECTRICA - C/MOTOR**

Máquina levanta cristal - 4 puertas -  
trasero -  
Mabuchi (8 dientes)



R-5228D  
O&M: AB392627000BC  
R-5228E  
O&M: AB392627001BC

Ranger 2012 em diante





**ELECTRICA - S/MOTOR**

Máquina levanta cristal - 2 puertas/4 puertas - delantero - Mabuchi (8 dientes)

R-7519D SM  
O&M: 698010K051 SM  
R-7519E SM  
O&M: 698020K051 SM



Hilux (picape e SW4) 2005 até abr/2015



**ELECTRICA - S/MOTOR - motor inverso**

Máquina levanta cristal - 4 puertas - trasero - Mabuchi (8 dientes)

R-7520D SM  
O&M: 698030K051 SM  
R-7520E SM  
O&M: 698040K051 SM



Hilux (picape e SW4) 2005 até out/2015  
Hilux (picape e SW4) SW4 2005 até nov/2015



**ELECTRICA - S/MOTOR**

Máquina levanta cristal - 2 puertas/4 puertas - delantero - Mabuchi (8 dientes)

R-7540D SM  
O&M: 698010K160 SM  
R-7540E SM  
O&M: 698020K160 SM



Hilux (picape e SW4) mai/2015 em diante



**ELECTRICA - S/MOTOR - motor inverso**

Máquina levanta cristal - 4 puertas - trasero - Mabuchi (8 dientes)

R-7541D SM  
O&M: 698030K130 SM  
R-7541E SM  
O&M: 698040K130 SM



Hilux (picape e SW4) nov/2015 em diante  
SW4 (2016 em diante) 2016 em diante



**ELECTRICA - C/MOTOR**

Máquina levanta cristal - 2 puertas/4 puertas - delantero - Mabuchi (8 dientes)

R-7519D  
O&M: 698010K051(CM)  
R-7519E  
O&M: 698020K051(CM)



Hilux (picape e SW4) 2005 até abr/2015



**ELECTRICA - C/MOTOR - motor inverso**

Máquina levanta cristal - 4 puertas - trasero - Mabuchi (8 dientes)

R-7520D  
O&M: 698030K051(CM)  
R-7520E  
O&M: 698040K051(CM)

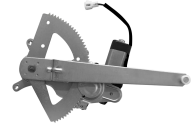

Hilux (picape e SW4) 2005 até out/2015  
Hilux (picape e SW4) SW4 2005 até nov/2015



**ELECTRICA - C/MOTOR**

Máquina levanta cristal - 2 puertas/4 puertas - delantero - Mabuchi (8 dientes)

R-7540D  
O&M: 698010K160  
R-7540E  
O&M: 698020K160



Hilux (picape e SW4) mai/2015 em diante



**ELECTRICA - C/MOTOR - motor inverso**

Máquina levanta cristal - 4 puertas - trasero - Mabuchi (8 dientes)

R-7541D  
O&M: 698030K130  
R-7541E  
O&M: 698040K130



Hilux (picape e SW4) nov/2015 em diante  
SW4 (2016 em diante) 2016 em diante



**MANUAL**

Máquina levanta cristal - 2 puertas - pin cuadrado

R-2620D  
O&M: 6980198001B  
R-2620E  
O&M: 6980298001B



Bandeirante 1967 até 1981

**MANUAL**

Máquina levanta cristal - 2 puertas - pin estriado

R-2621D  
O&M: 6980198002A  
R-2621E  
O&M: 6980298002A



Bandeirante 1982 até 1983

**MANUAL**

Máquina levanta cristal - 2 puertas - pin estriado

R-2622D  
O&M: 6980198003  
R-2622E  
O&M: 6980298003



Bandeirante 1984 até 2001

**ELECTRICA - S/MOTOR**

Máquina levanta cristal - 4 puertas - delantero - Mabuchi (8 dientes)



R-7490D SM  
O&M: MN182366 SM  
R-7490E SM  
O&M: MN182365 SM

L-200 Triton 2008 em diante

**ELECTRICA - S/MOTOR - motor inverso**

Máquina levanta cristal - 4 puertas - trasero - Mabuchi (8 dientes)



R-7491D SM  
O&M: MN182404 SM  
R-7491E SM  
O&M: MN182403 SM

L-200 Triton 2008 em diante

**ELECTRICA - S/MOTOR**

Máquina levanta cristal - 4 puertas - delantero - Mabuchi (8 dientes)



R-7492D SM  
O&M: MR144530 SM  
R-7492E SM  
O&M: MR144529 SM

L-200 Outdoor 2006 até 2011  
L-200 Sport 2004 até 2011  
Pajero Sport 2004 até 2011

**ELECTRICA - C/MOTOR**

Máquina levanta cristal - 4 puertas - delantero - Mabuchi (8 dientes)



R-7490D  
O&M: MN182366  
R-7490E  
O&M: MN182365

L-200 Triton 2008 em diante

**ELECTRICA - C/MOTOR - motor inverso**

Máquina levanta cristal - 4 puertas - trasero - Mabuchi (8 dientes)



R-7491D  
O&M: MN182404  
R-7491E  
O&M: MN182403

L-200 Triton 2008 em diante

**ELECTRICA - C/MOTOR**

Máquina levanta cristal - 4 puertas - delantero - Mabuchi (8 dientes)



R-7492D  
O&M: MR144530  
R-7492E  
O&M: MR144529

L-200 Outdoor 2006 até 2011  
L-200 Sport 2004 até 2011  
Pajero Sport 2004 até 2011

**MANUAL**

Máquina levanta cristal -  
2 puertas/4 puertas -  
delantero

R-7799D  
O&M: 80720Z710  
R-7799E  
O&M: 80721Z710



Frontier 1998 até 2007

**ELECTRICA - S/MOTOR**

Máquina levanta cristal -  
2 puertas/4 puertas -  
delantero -  
original (8 dientes)

R-7802D SM  
O&M: 80720EB71A SM  
R-7802E SM  
O&M: 80721EB71A SM

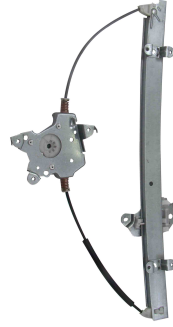

Frontier 2007 até 2019

**ELECTRICA - S/MOTOR**

Máquina levanta cristal - 4 puertas -  
trasero -  
original (eje cuadrado)

R-7803D SM  
O&M: 82720JR20A SM  
R-7803E SM  
O&M: 82721JR20A SM

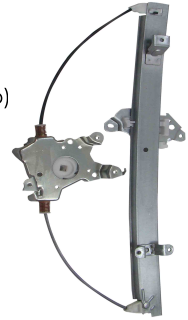

Frontier 2007 até 2019

**ELECTRICA - S/MOTOR**

Máquina levanta cristal -  
2 puertas/4 puertas -  
delantero -  
Mabuchi (8 dientes)

R-7806D SM  
O&M: 80720EB71A SM  
R-7806E SM  
O&M: 80721EB71A SM



Frontier 2007 até 2019

**ELECTRICA - S/MOTOR**

Máquina levanta cristal - 4 puertas -  
trasero -  
Mabuchi (8 dientes)

R-7807D SM  
O&M: 82720JR20A SM  
R-7807E SM  
O&M: 82720JR20A SM



Frontier 2007 até 2019

**ELECTRICA - S/MOTOR**

Máquina levanta cristal - 4 puertas -  
delantero -  
Mabuchi (8 dientes)

R-7809D SM  
O&M: 807214KH0A SM  
R-7809E SM  
O&M: 807204KH0A SM



Frontier 2021 em diante

**ELECTRICA - C/MOTOR**

Máquina levanta cristal -  
2 puertas/4 puertas -  
delantero -  
Mabuchi (8 dientes)

R-7806D  
O&M: 80720EB71A  
R-7806E  
O&M: 80721EB71A



Frontier 2007 até 2019

**ELECTRICA - C/MOTOR**

Máquina levanta cristal - 4 puertas -  
trasero -  
Mabuchi (8 dientes)

R-7807D  
O&M: 82720JR20A  
R-7807E  
O&M: 82721JR20A



Frontier 2007 até 2019

**ELECTRICA - C/MOTOR**

Máquina levanta cristal - 4 puertas -  
delantero -  
Mabuchi (8 dientes)

R-7809D  
O&M: 807214KH0A  
R-7809E  
O&M: 807204KH0A



Frontier 2021 em diante

**MANUAL**

Máquina levanta  
cristal



R-7702D  
R-7702E

Maruá 2005 em diante



Est. Água Chata, 1233, Bonsucesso  
Guarulhos, SP - CEP 07251-000  
**(11) 2088-7200**