

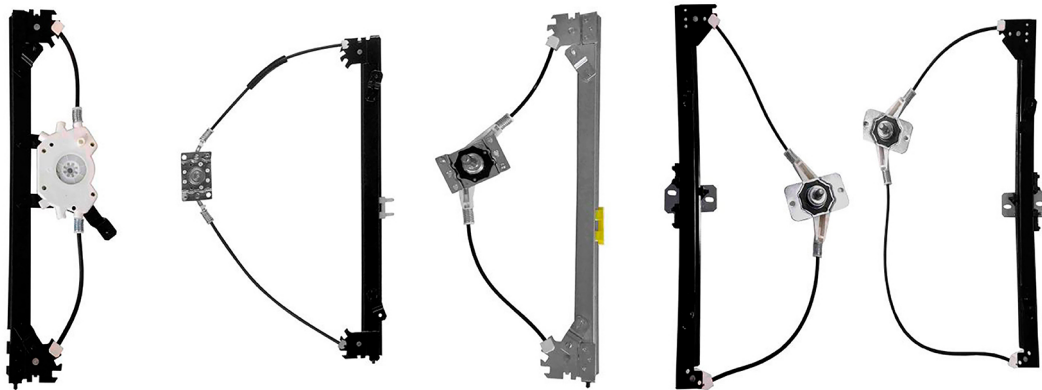

Zinni & Güell

Indústria de Auto Peças Ltda.



LINEA PICK-UP

SIN MÁQUINAS LEVANTA CRISTAL ELECTRICAS CON MOTOR



Canal de YouTube - pionero con consejos e instalaciones de productos

● GM	1
● VOLKSWAGEN	3
● FORD	4
● TOYOTA	6
● MITSUBISHI	7
● NISSAN	8
● AGRALE	9

Bisagra tapa
delantera - con
resorte

D-3383D
O&M: 7362032
D-3383E
O&M: 7362031



A-10 até 1984
C-10 até 1984
D-10 até 1984

Bisagra tapa
delantera - con
resorte

D-3384D
O&M: 94630704
D-3384E
O&M: 94630703



C-20 1985 em diante
D-20 1985 em diante
D-40 1985 em diante

Bisagra tapa
delantera - soporte

S-3385



A-10 até 1984
C-10 até 1984
D-10 até 1984

MANUAL

Máquina levanta
cristal - 2 puertas -
delantero

R-3114D
O&M: 7320092
R-3114E
O&M: 7320091



C-10 1972 até 1985
D-10 1979 até 1985
D-60 1965 até 1985
Veraneio 1971 até 1985



MANUAL

Máquina levanta
cristal - 2 puertas

R-3116D
O&M: 94637552
R-3116E
O&M: 94637551



A-20 1985 até 1990
A-40 1985 até 1990
C-20 1985 até 1990
D-20 1985 até 1990
D-40 1985 até 1990



MANUAL

Máquina levanta
cristal -
2 puertas/4 puertas -
delantero

R-3346D
O&M: 52255122
R-3346E
O&M: 52255121

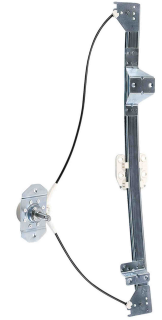

A-20 1991 até 1996
A-40 1991 até 1996
Bonanza 1991 até 1994
C-20 1991 até 1996
D-12000 1991 até 1996
D-20 1991 até 1996
D-40 1991 até 1996
Veraneio 1991 até 1994



MANUAL

Máquina levanta
cristal - 4 puertas -
trasero

R-3347D
O&M: 52255126
R-3347E
O&M: 52255125



A-20 1991 até 1996
A-40 1991 até 1996
Bonanza 1991 até 1994
C-20 1991 até 1996
D-12000 1991 até 1996
D-20 1991 até 1996
D-40 1991 até 1996
Veraneio 1991 até 1994



MANUAL

Máquina levanta
cristal -
2 puertas/4 puertas -
delantero

R-3345D
O&M: 15705142
R-3345E
O&M: 15705141



Blazer 1995 até 2011
S10 1995 até 2011



ELECTRICA - S/MOTOR - motor inverso

Máquina levanta
cristal - 4 puertas -
delantero -
Mabuchi (8 dientes)

R-3332D SM
O&M: 52255124 SM
R-3332E SM
O&M: 52255123 SM

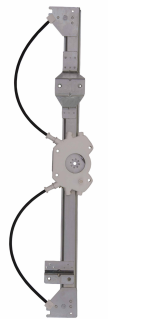

A-20 1991 até 1996
Bonanza 1991 até 1994
C-20 1991 até 1996
D-20 1991 até 1996
Veraneio 1991 até 1994



ELECTRICA - S/MOTOR

Máquina levanta
cristal - 4 puertas -
trasero -
Mabuchi (8 dientes)

R-3333D SM
O&M: 52255128 SM
R-3333E SM
O&M: 52255127 SM



A-20 1991 até 1996
Bonanza 1991 até 1994
C-20 1991 até 1996
D-20 1991 até 1996
Veraneio 1991 até 1994



ELECTRICA - S/MOTOR - motor inverso

Máquina levanta
cristal -
2 puertas/4 puertas -
delantero -
Mabuchi (8 dientes)

R-3344D SM
O&M: 15705144 SM
R-3344E SM
O&M: 15705143 SM



Blazer 1995 até 2011
S10 1995 até 2011



ELECTRICA - S/MOTOR

Máquina levanta
cristal -
2 puertas/4 puertas -
delantero -
Mabuchi (8 dientes)

R-3357D SM
O&M: 947736650 SM
R-3357E SM
O&M: 947736649 SM



S10 2012 em diante

ELECTRICA - S/MOTOR - motor inverso

Máquina levanta cristal - 4 puertas - trasero - Mabuchi (8 dientes)

R-3358D SM
O&M: 5483149 SM
R-3358E SM
O&M: 5483148 SM



S10 2012 em diante

ELECTRICA - S/MOTOR - motor inverso

Máquina levanta cristal - 4 puertas - trasero - Mabuchi (8 dientes) - el cristal baja hasta el final del curso

R-3363D SM
O&M: 5483149 SM
R-3363E SM
O&M: 5483148 SM



S10 2012 em diante

ELECTRICA - S/MOTOR

Máquina levanta cristal - delantero - original

R-4143D SM
O&M: 2H0837402H
R-4143E SM
O&M: 2H0837401L



Amarok 2010 em diante

Reparación máquina levanta cristal eléctricos - 2 puertas - delantero - sin motor - Mabuchi (8 dientes)

R-4178D SM
O&M: IJ3837462 SM
R-4178E SM
O&M: IJ3837461 SM



Amarok 2010 em diante
Golf 1999 até 2014
Polo 2002 até 2014

Reparación máquina levanta cristal eléctricos - 2 puertas - delantero - con motor - Mabuchi (8 dientes)

R-4178D
O&M: IJ3837462
R-4178E
O&M: IJ3837461



Amarok 2010 em diante
Golf 1999 até 2014
Polo 2002 até 2014

Bisagra tapa delantera - con resorte



D-5238D
O&M: 90TU16800A
D-5238E
O&M: 90TU16801A

F-1000 até 1992
F-4000 até 1992

Bisagra tapa delantera - con resorte



D-5239D
O&M: TNK823335
D-5239E
O&M: EITQ16796A

F-1000 1992 até 1998
F-4000 1992 até 1998

Cierre del capot - inferior

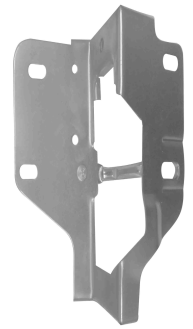

F-5242I
O&M: 89TU16900AA

F-1000 até 1989
F-4000 até 1989

Cierre del capot - superior - sin cable

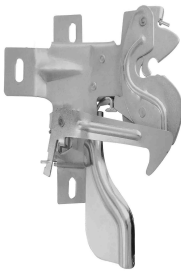

F-5242S
O&M: DOTB16700B

F-1000 até 1989
F-11000 até 1989
F-14000 até 1989
F-4000 até 1989
F-7000 até 1989

Cierre del capot - superior - con cable

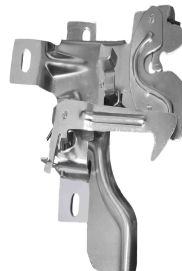

F-5243S
O&M: 89TU16700AA

F-1000 1989 até 1992
F-11000 1989 até 1992
F-14000 1989 até 1992
F-4000 1989 até 1992
F-7000 1989 até 1992

MANUAL

Máquina levanta cristal - 2 puertas



R-5223D
O&M: BD3B98231WOO
R-5223E
O&M: BD3B98231WOI

F-75 1970 até 1982
Rural Willys 1956 até 1977

MANUAL

Máquina levanta cristal - 2 puertas



R-5141D
O&M: BD3C8123200A
R-5141E
O&M: BD3C8123201A

F-100 1972 até 1986
F-1000 1979 até 1991
F-11000 1981 até 1991
F-4000 1985 até 1991



MANUAL

Máquina levanta cristal - 2 puertas



R-5149D
O&M: T71837502D
R-5149E
O&M: T71837501D

F-1000 1992 até 1998 modelo Sapão
F-12000 1992 até 1998 modelo Sapão
F-14000 1992 até 1998 modelo Sapão
F-4000 1992 até 1998 modelo Sapão



MANUAL

Máquina levanta cristal - 2 puertas / 4 puertas - delantero



R-5226D
O&M: XC3Z2523200AA
R-5226E
O&M: XC3Z2523201AA

F-12000 1999 até 2006 Pit Bull
F-14000 1999 até 2016 Pit Bull
F-16000 1999 até 2016 Pit Bull
F-250 1998 até 2012
F-350 1999 até 2010
F-4000 1998 até 2012



MANUAL

Máquina levanta cristal - 4 puertas - trasero



R-5247D
O&M: 8C3Z2627000A
R-5247E
O&M: 8C3Z2627001A

F-250 1998 até 2012
F-350 1999 até 2010
F-4000 1998 até 2012

MANUAL

Máquina levanta cristal - 2 puertas / 4 puertas - delantero



R-5146D
O&M: F37Z1023200A
R-5146E
O&M: F37Z1023201A

Ranger 1994 até 2011



MANUAL

Máquina levanta cristal - 4 puertas - trasero



R-5154D
O&M: YL543527000AA
R-5154E
O&M: YL543527001AA

Ranger 1998 até 2011



ELECTRICA - S/MOTOR - motor inverso

Máquina levanta cristal - 2 puertas - Mabuchi (8 dientes)



R-5222D SM
O&M: 89TU81234W00B SM
R-5222E SM
O&M: 89TU81234W01B SM

F-1000 1979 até 1991
F-4000 1985 até 1991
F-600 1972 até 1979



ELECTRICA - S/MOTOR - motor inverso

Máquina levanta cristal - 2 puertas - Mabuchi (8 dientes)

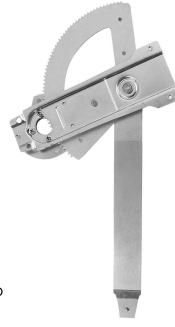

R-5229D SM
O&M: 2SA837502A SM
R-5229E SM
O&M: 2SA837501A SM

F-1000 1992 até 1998 modelo Sapão
F-12000 1992 até 1998 modelo Sapão
F-14000 1992 até 1998 modelo Sapão
F-4000 1992 até 1998 modelo Sapão



ELECTRICA - S/MOTOR

Máquina levanta cristal - 2 puertas/4 puertas - delantero - Mabuchi (8 dientes)



R-5235D SM
O&M: XC3Z2523200BA SM
R-5235E SM
O&M: XC3Z2523201BA SM

F-12000 1999 até 2006 Pit Bull
F-14000 1999 até 2016 Pit Bull
F-16000 1999 até 2016 Pit Bull
F-250 1998 até 2012
F-350 1999 até 2010
F-4000 1998 até 2012



ELECTRICA - S/MOTOR

Máquina levanta cristal - 2 puertas - trasero - Mabuchi (8 dientes)



R-5248D SM
O&M: 8C3Z2627000B SM
R-5248E SM
O&M: 8C3Z2627001B SM

F-250 1998 até 2012
F-350 1999 até 2010
F-4000 1998 até 2012

ELECTRICA - S/MOTOR - motor inverso

Máquina levanta cristal - 2 puertas/4 puertas - delantero - Mabuchi (8 dientes)



R-5147D SM
O&M: F57Z/1023208/AA SM
R-5147E SM
O&M: F57Z/1023209/AA SM

Ranger 1994 até 2011



ELECTRICA - S/MOTOR

Máquina levanta cristal - 4 puertas - trasero - Mabuchi (8 dientes)



R-5153D SM
O&M: 7L553527000AA SM
R-5153E SM
O&M: 7L553527001AA SM

Ranger 1998 até 2011



ELECTRICA - S/MOTOR

Máquina levanta cristal - 2 puertas/4 puertas - delantero - Mabuchi (8 dientes)



R-5227D SM
O&M: AB392123200BC SM
R-5227E SM
O&M: AB392123201BC SM

Ranger 2012 em diante



ELECTRICA - S/MOTOR

Máquina levanta cristal - 4 puertas - delantero - original (34 estrias)



R-5253D SM
O&M: AB392123200
R-5253E SM
O&M: AB392123201

Ranger 2012 em diante

ELECTRICA - S/MOTOR

Máquina levanta cristal - 4 puertas - trasero - Mabuchi (8 dientes)



R-5228D SM
O&M: AB392627000BC SM
R-5228E SM
O&M: AB392627001BC SM

Ranger 2012 em diante



ELECTRICA - S/MOTOR

Máquina levanta cristal - 4 puertas - trasero - original (32 estrias)



R-5157D SM
O&M: AB392627000BC/CCS SM
R-5157E SM
O&M: AB392627001BC/CCS SM

Ranger 2012 em diante



ELECTRICA - S/MOTOR

Máquina levanta cristal -
2 puertas/4 puertas -
delantero -
Mabuchi (8 dientes)

R-7519D SM
O&M: 698010K051 SM
R-7519E SM
O&M: 698020K051 SM



Hilux (picape e SW4) 2005 até
abr/2015



ELECTRICA - S/MOTOR - motor inverso

Máquina levanta
cristal - 4 puertas -
trasero -
Mabuchi (8 dientes)

R-7520D SM
O&M: 698030K051 SM
R-7520E SM
O&M: 698040K051 SM



Hilux (picape e SW4) 2005 até
out/2015
Hilux (picape e SW4) SW4 2005
até nov/2015



ELECTRICA - S/MOTOR

Máquina levanta
cristal -
2 puertas/4 puertas -
delantero -
Mabuchi (8 dientes)

R-7540D SM
O&M: 698010K160 SM
R-7540E SM
O&M: 698020K160 SM



Hilux (picape e SW4) mai/2015
em diante



ELECTRICA - S/MOTOR - motor inverso

Máquina levanta
cristal - 4 puertas -
trasero -
Mabuchi (8 dientes)

R-7541D SM
O&M: 698030K130 SM
R-7541E SM
O&M: 698040K130 SM



Hilux (picape e SW4) nov/2015
em diante
SW4 (2016 em diante) 2016 em
diante



MANUAL

Máquina levanta
cristal - 2 puertas -
pin cuadrado

R-2620D
O&M: 6980198001B
R-2620E
O&M: 6980298001B



Bandeirante 1967 até 1981

MANUAL

Máquina levanta
cristal - 2 puertas -
pin estriado

R-2621D
O&M: 6980198002A
R-2621E
O&M: 6980298002A



Bandeirante 1982 até 1983

MANUAL

Máquina levanta
cristal - 2 puertas -
pin estriado

R-2622D
O&M: 6980198003
R-2622E
O&M: 6980298003



Bandeirante 1984 até 2001

ELECTRICA - S/MOTOR

Máquina levanta cristal - 4 puertas - delantero - Mabuchi (8 dientes)

R-7490D SM
O&M: MN182366 SM
R-7490E SM
O&M: MN182365 SM



L-200 Triton 2008 em diante

ELECTRICA - S/MOTOR - motor inverso

Máquina levanta cristal - 4 puertas - trasero - Mabuchi (8 dientes)

R-7491D SM
O&M: MN182404 SM
R-7491E SM
O&M: MN182403 SM



L-200 Triton 2008 em diante

ELECTRICA - S/MOTOR

Máquina levanta cristal - 4 puertas - delantero - Mabuchi (8 dientes)

R-7492D SM
O&M: MRI44530 SM
R-7492E SM
O&M: MRI44529 SM



L-200 Outdoor 2006 até 2011
L-200 Sport 2004 até 2011
Pajero Sport 2004 até 2011

MANUAL

Máquina levanta cristal -
2 puertas/4 puertas -
delantero

R-7799D
O&M: 807202Z710
R-7799E
O&M: 807212Z710



Frontier 1998 até 2007

ELECTRICA - S/MOTOR

Máquina levanta cristal -
2 puertas/4 puertas -
delantero -
original (8 dientes)

R-7802D SM
O&M: 80720EB71A SM
R-7802E SM
O&M: 80721EB71A SM

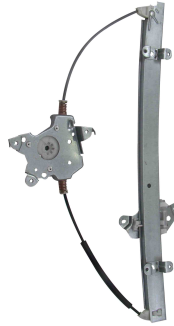

Frontier 2007 até 2019

ELECTRICA - S/MOTOR

Máquina levanta cristal - 4 puertas -
trasero -
original (eje cuadrado)

R-7803D SM
O&M: 82720JR20A SM
R-7803E SM
O&M: 82721JR20A SM

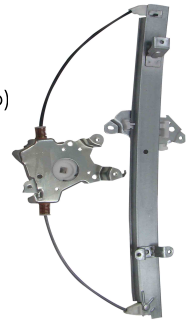

Frontier 2007 até 2019

ELECTRICA - S/MOTOR

Máquina levanta cristal -
2 puertas/4 puertas -
delantero -
Mabuchi (8 dientes)

R-7806D SM
O&M: 80720EB71A SM
R-7806E SM
O&M: 80721EB71A SM



Frontier 2007 até 2019

ELECTRICA - S/MOTOR

Máquina levanta cristal - 4 puertas -
trasero -
Mabuchi (8 dientes)

R-7807D SM
O&M: 82720JR20A SM
R-7807E SM
O&M: 82720JR20A SM



Frontier 2007 até 2019

ELECTRICA - S/MOTOR

Máquina levanta cristal - 4 puertas -
delantero -
Mabuchi (8 dientes)

R-7809D SM
O&M: 807214KH0A SM
R-7809E SM
O&M: 807204KH0A SM



Frontier 2021 em diante

MANUAL

Máquina levanta
cristal

R-7702D
R-7702E



Maruá 2005 em diante



Est. Água Chata, 1233, Bonsucesso
Guarulhos, SP - CEP 07251-000
(11) 2088-7200